

# HYUNDAI

new thinking  
new possibilities

---



LIGHTING  
SOLUTIONS



# CONTENT:

## INDOOR LIGHTING

■ LED PANELS	05-11
■ LED CEILING LAMP	13-17
■ LIGHTING FIXTURE WITH MOVEMENT SENSOR	18-19
■ COB LED DOWNLIGHTS	21
■ LED TRACK LUMINAIRE	23-25
■ LED BATTEN FITTINGS	27-29
■ LED BATHROOM	31
■ LED WATERPROOF LUMINAIRE	33-35
■ LED STRIPS AND POWER SUPPLIES	37-39
■ RECHARGEABLE EMERGENCY FIXTURES	41-43
■ LED WORK LAMP	45

## OUTDOOR LIGHTING

■ LED PROJECTORS	47-49
■ LED STREET LIGHTS	51
■ LED HIGH BAY	53
■ GARDEN FIXTURES	55-71

## LIGHT SOURCES

■ LED SMD BULBS	73-74
■ LED HIGH WATTAGE	75
■ LED SPOTLIGHTS	76
■ LED CAPSULES	77
■ LED FILAMENT BULBS	78-79
■ LED TUBES	81
■ INCANDESCENT BULBS	82
■ FLUORESCENT TUBES	83
■ HID LAMPS	84-85

## SPECIAL FIXTURES

■ INSECT KILLERS	87
------------------	----

## EXTENSION CORDS AND CABLE REELS

■ CABLE REELS	89
■ EXTENSION CORDS	90-91

## ELECTRICAL INSTALLATION EQUIPMENT

■ MOTION SENSORS	93-94
■ WI-FI SOCKET	95
■ PHOTO SENSORS	96
■ FANS, TIMERS	97
■ PLUGS, ADAPTERS, LAMP HOLDERS	99-100
■ LAMP HOLDERS	101
■ CABLES, CABLE TIES	102-103



# CATEGORIES:

INDOOR LIGHTING



OUTDOOR LIGHTING



LIGHT SOURCES



SPECIAL FIXTURES



EXTENSION CORDS



ELECTRICAL EQUIPMENT





BACKLITE  
E  
D  
PANEL

## Led Backlite Panels



Code	Model no.	Input Voltage (V)	Nominal Power (W)	Color Temperature (K)	Power Factor	Lumen (lm)	CRI	Beam angle	Life (hrs)	Dimensions (mm)	Cut Out (mm)	Quantity (pcs/ctn)
490734	HY/LED/BLP/40W /4000K/600X600	220-240VAC	40W	4000K	0.9	4000	≥80	120°	40000	595*595*38	600x600	1/4
490735	HY/LED/BLP/40W /6500K/600X600	220-240VAC	40W	6500K	0.9	4000	≥80	120°	40000	595*595*38	600x600	1/4

## Accessories

### Ceiling Mount Accessories



Code	Model no.	Set
490734-3	HY/CM/BLP/SET/600X600	1/4

### Hanging Accessories



Code	Model no.	Set
490734-1	HY/H/BLP/SET/600X600	1/4

### Accessories for mounting on plasterboard



Code	Model no.	Set
490734-2	HY/PB/BLP/SET/600X600	1/4



EDGELITE  
E  
D  
PANEL

## Led Edgelite Panels

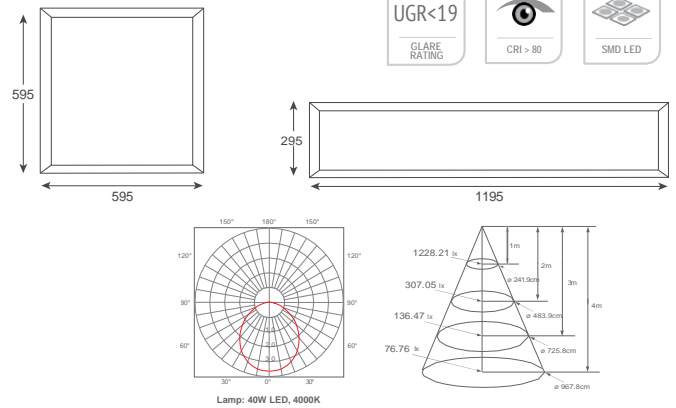

Code	Model no.	Input Voltage (V)	Nominal Power (W)	Color Temp.(K)	Power Factor	Lumen (lm)	CRI	Beam angle	Life (hrs)	Dimensions (mm)	Cut Out (mm)	Quantity (pcs/ctn)
490738	HY/LED/PA/40W/4000K/600X600	220-240VAC	40W	4000K	0.9	3200	$\geq 80$	120°	40000	595x595x9	600x600	1/4
490736	HY/LED/PA/36W/6500K/600X600	220-240VAC	36W	6500K	0.9	3200	$\geq 80$	120°	40000	595x595x9	600x600	1/4
490739	HY/LED/PA/40W/4000K/300X1200	220-240VAC	40W	4000K	0.9	3200	$\geq 80$	120°	40000	295x1195x9	300x1200	1/5
490737	HY/LED/PA/36W/6500K/300X1200	220-240VAC	36W	6500K	0.9	3200	$\geq 80$	120°	40000	295x1195x9	300x1200	1/5

## Accessories

### Ceiling Mount Accessories



Code	Model no.	Set
490738-3	HY/CM/SET/600X600	1/4
490739-3	HY/CM/SET/300X1200	1/4

### Hanging Accessories

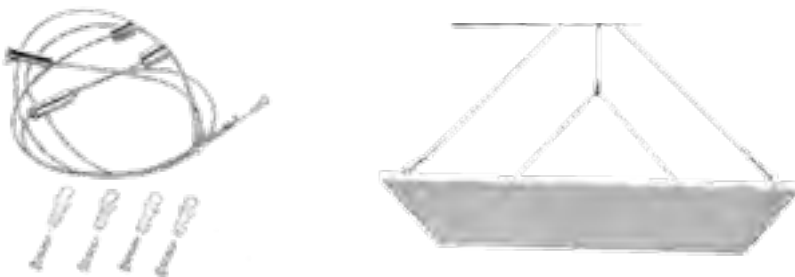

Code	Model no.	Quantity (pcs/ctn)
490738-1	HY/H/SET/600X600	1/4
490739-1	HY/H/SET/300X1200	1/6

### Accessories for mounting on plasterboard



Code	Model no.	Set
490738-2	HY/PB/SET/600X600	1/4
490739-2	HY/PB/SET/300X1200	1/6

# FEED CLIP-ON PANEL

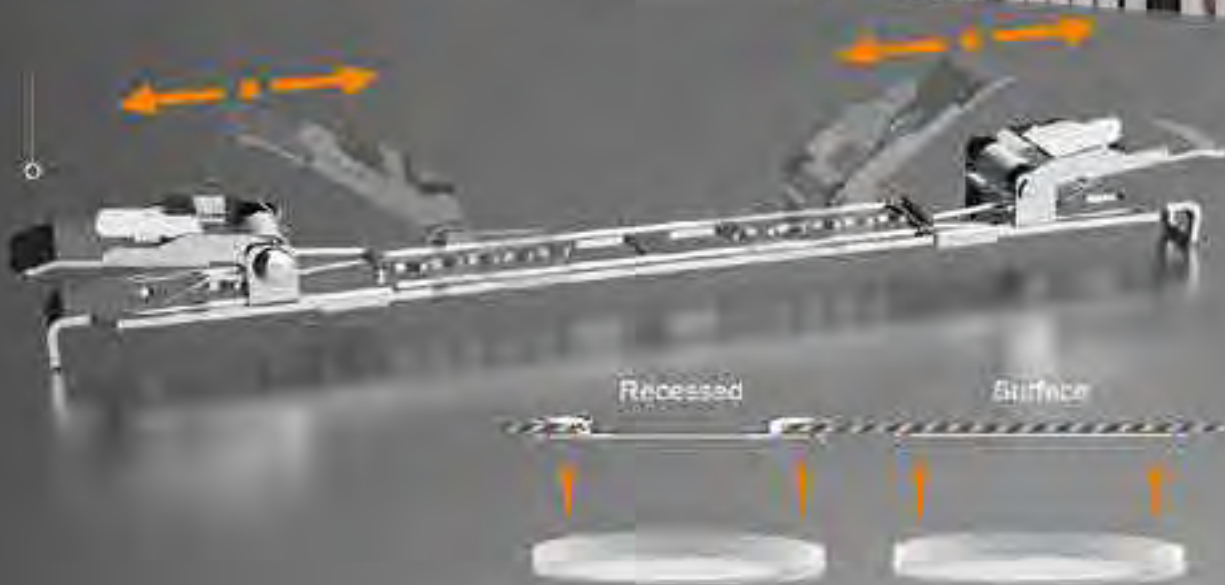

30CT By 4 Model



DIV Colorful Ring



**3CCT Version**

Thickness 15mm

LED

4 modes 3CCT Switch

Self-Lock Inside

Alu Heat Sink Inside

**3 CCT Changeable**

Changeable 3000K/4000K/6000K

1000 2000 3000 4000 5000 6000 7000 8000

Warm Neutral Cool

Warm White 3,000K Neutral White 4,000K Cool White 6,000K

Two ways to adjust CCT:  
Switch on fixture before installing  
or  
Using wall switch after installation

## Clip-on Thermal Plastic Led Panel

LED

2 years warranty

A++ A

IP40 RoHS EMC

CRI > 80 SMD LED

Beam angle diagram showing 110° spread.

Dimensions: 1228.21 lx, 307.05 lx, 136.47 lx, 76.76 lx, 1m, 2m, 3m, 4m, 245.0mm, 483.0mm, 725.0mm, 967.0mm.

Code	Model no.	Input voltage Nomial (V)	Power (W)	3CCT Changeable	Color Temp. (K)	Lumen (lm)	CRI (Ra)	Beam angle (°)	Life (hrs)	Dimensions (mm)	Cut Out (mm)	Quantity (pcs/ctn)
490880	HY/LED/CLIP-ON/6W/3CCT	100-240VAC	6W	Yes	3000K/4000K/6500K	420 lm	≥80	110°	40000	Ø139x15mm	Ø55-100mm	1/60
490881	HY/LED/CLIP-ON/12W/3CCT	100-240VAC	12W	Yes	3000K/4000K/6500K	1040 lm	≥80	110°	40000	Ø164x15mm	Ø55-125mm	1/40
490882	HY/LED/CLIP-ON/18W/3CCT	100-240VAC	18W	Yes	3000K/4000K/6500K	1750 lm	≥80	110°	40000	Ø217x15mm	Ø55-175mm	1/20
490883	HY/LED/CLIP-ON/24W/3CCT	100-240VAC	24W	Yes	3000K/4000K/6500K	2300 lm	≥80	110°	40000	Ø292x15mm	Ø55-250mm	1/10

## Accessories Metal Color Ring

Code	Model no.	Color Temp. (K)	Dimensions (mm)
490884	HY/CLIP-ON/RING/18W/BN	Brushed Nickel	Ø219 x h15mm
490885	HY/CLIP-ON/RING/18W/PB	Polishead Black	Ø219 x h15mm
490886	HY/CLIP-ON/RING/18W/BB	Brushed Bronze	Ø219 x h15mm
490887	HY/CLIP-ON/RING/24W/BN	Brushed Nickel	Ø293 x h15mm
490888	HY/CLIP-ON/RING/24W/PB	Polishead Black	Ø293 x h15mm
490889	HY/CLIP-ON/RING/24W/BB	Brushed Bronze	Ø293 x h15mm

DIY Colorful Ring

Accessories  
Optional Color Ring

Black Silver Bronze Red-Gold

## Recessed Round Thermal Plastic Led Panel

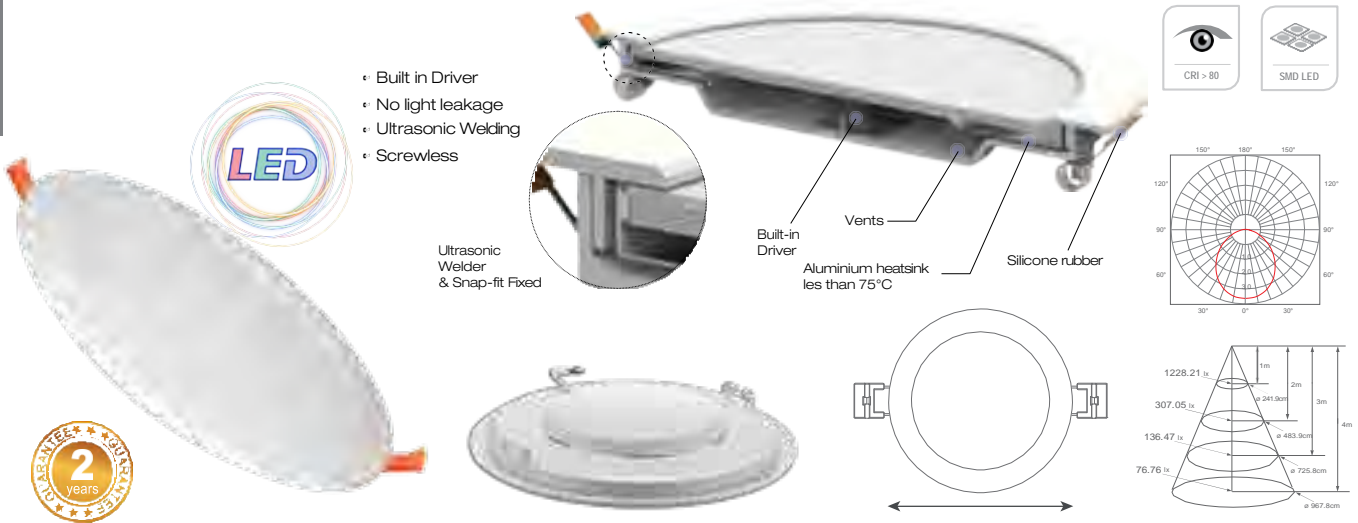

Code	Model no.	Input voltage (V)	Nomial Power (W)	Color Temp. (K)	Power factor	Lumen (Lm)	CRI (Ra)	Beam angle (°)	Life (hrs)	Dimesions (mm)	Cut Out (mm)	Quantity (pcs/ctn)
490830-1	HY/LED/RP/PC/6W/4000K	100-240VAC	6W	4000K	0.9	480 lm	≥80	120°	40000	f-120mm	f-107mm	1/60
49083011	HY/LED/RP/PC/6W/6500K	100-240VAC	6W	6500K	0.9	480 lm	≥80	120°	40000	f-120mm	f-107mm	1/60
490831-1	HY/LED/RP/PC/12W/4000K	100-240VAC	12W	4000K	0.9	960 lm	≥80	120°	40000	f-168mm	f-155mm	1/40
49083111	HY/LED/RP/PC/12W/6500K	100-240VAC	12W	6500K	0.9	960 lm	≥80	120°	40000	f-168mm	f-155mm	1/40
490833-1	HY/LED/RP/PC/18W/4000K	100-240VAC	18W	4000K	0.9	1440 lm	≥80	120°	40000	f-225mm	f-207mm	1/20
49083311	HY/LED/RP/PC/18W/6500K	100-240VAC	18W	6500K	0.9	1440 lm	≥80	120°	40000	f-225mm	f-207mm	1/20
490834-1	HY/LED/RP/PC/24W/4000K	100-240VAC	24W	4000K	0.9	1920 lm	≥80	120°	40000	f-298mm	f-273mm	1/10
49083411	HY/LED/RP/PC/24W/6500K	100-240VAC	24W	6500K	0.9	1920 lm	≥80	120°	40000	f-298mm	f-273mm	1/10

## Recessed Square thermal plastic Led Panel

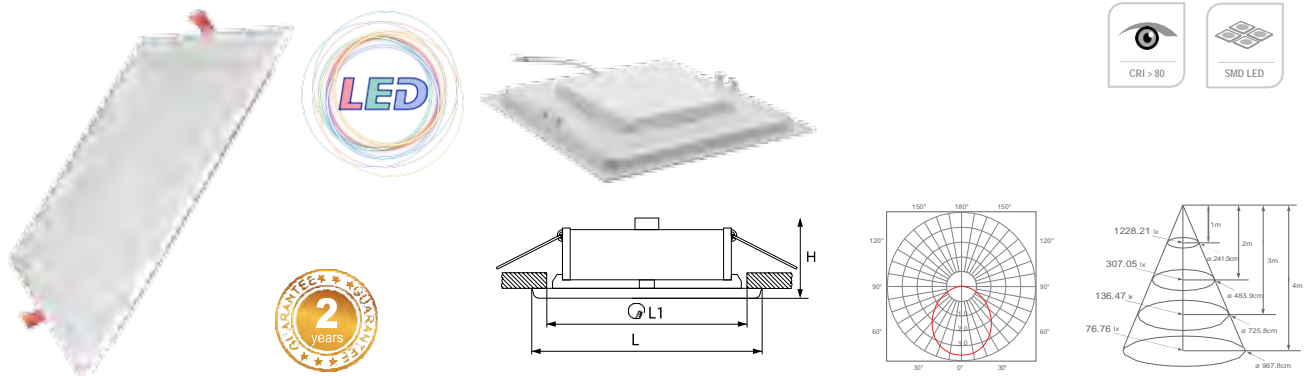

Code	Model no.	Input voltage (V)	Nomial Power (W)	Color Temp. (K)	Power factor	Lumen (Lm)	CRI (Ra)	Beam angle (°)	Life (hrs)	Dimensions (mm)	Cut Out (mm)	Quantity (pcs/ctn)
490825-1	HY/LED/SL/PC/6W/4000K	100-240VAC	6W	4000K	0.9	480 lm	≥80	120°	40000	120x120mm	100x100mm	1/60
49082511	HY/LED/SL/PC/6W/6500K	100-240VAC	6W	6500K	0.9	480 lm	≥80	120°	40000	120x120mm	100x100mm	1/60
490826-1	HY/LED/SL/PC/12W/4000K	100-240VAC	12W	4000K	0.9	960 lm	≥80	120°	40000	168x168mm	148x148mm	1/40
49082611	HY/LED/SL/PC/12W/6500K	100-240VAC	12W	6500K	0.9	960 lm	≥80	120°	40000	168x168mm	148x148mm	1/40
490828-1	HY/LED/SL/PC/18W/4000K	100-240VAC	18W	4000K	0.9	1440 lm	≥80	120°	40000	225x225mm	200x200mm	1/20
49082811	HY/LED/SL/PC/18W/6500K	100-240VAC	18W	6500K	0.9	1440 lm	≥80	120°	40000	225x225mm	200x200mm	1/20
490829-1	HY/LED/SL/PC/24W/4000K	100-240VAC	24W	4000K	0.9	1920 lm	≥80	120°	40000	298x298mm	277x277mm	1/10
49082911	HY/LED/SL/PC/24W/6500K	100-240VAC	24W	6500K	0.9	1920 lm	≥80	120°	40000	298x298mm	277x277mm	1/10

## Surface Round Thermal Plastic Led Panels

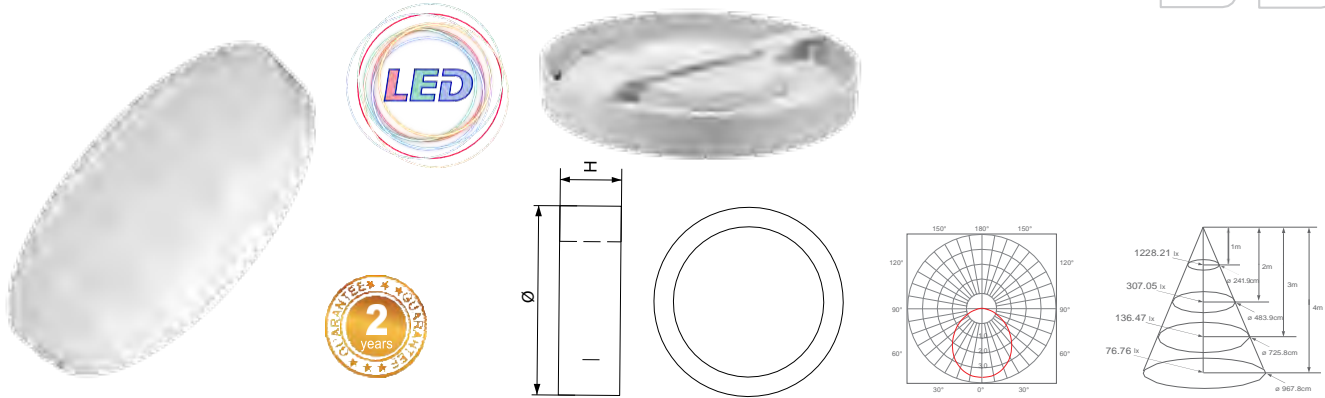

Code	Model no.	Input voltage (V)	Nomial Power (W)	Color Temp. (K)	Power factor	Lumen (Lm)	CRI (Ra)	Beam angle (°)	Life (hrs)	Dimensions (mm)	Quantity (pcs/ctn)
490684-4	HY/LED/SRLP/PC/6W/4000K	100-240VAC	6W	4000K	0.9	450	≥80	120°	40000	120mm	1/60
49068441	HY/LED/SRLP/PC/6W/6500K	100-240VAC	6W	6500K	0.9	450	≥80	120°	40000	120mm	1/60
490684-5	HY/LED/SRLP/PC/12W/4000K	100-240VAC	12W	4000K	0.9	960	≥80	120°	40000	168mm	1/40
49068451	HY/LED/SRLP/PC/12W/6500K	100-240VAC	12W	6500K	0.9	960	≥80	120°	40000	168mm	1/40
490684-6	HY/LED/SRLP/PC/18W/4000K	100-240VAC	18W	4000K	0.9	1440	≥80	120°	40000	225mm	1/20
49068461	HY/LED/SRLP/PC/18W/6500K	100-240VAC	18W	6500K	0.9	1440	≥80	120°	40000	225mm	1/20
490684-7	HY/LED/SRLP/PC/24W/4000K	100-240VAC	24W	4000K	0.9	1920	≥80	120°	40000	298mm	1/10
49068471	HY/LED/SRLP/PC/24W/6500K	100-240VAC	24W	6500K	0.9	1920	≥80	120°	40000	298mm	1/10

## Surface Square Thermal Plastic Led Panels

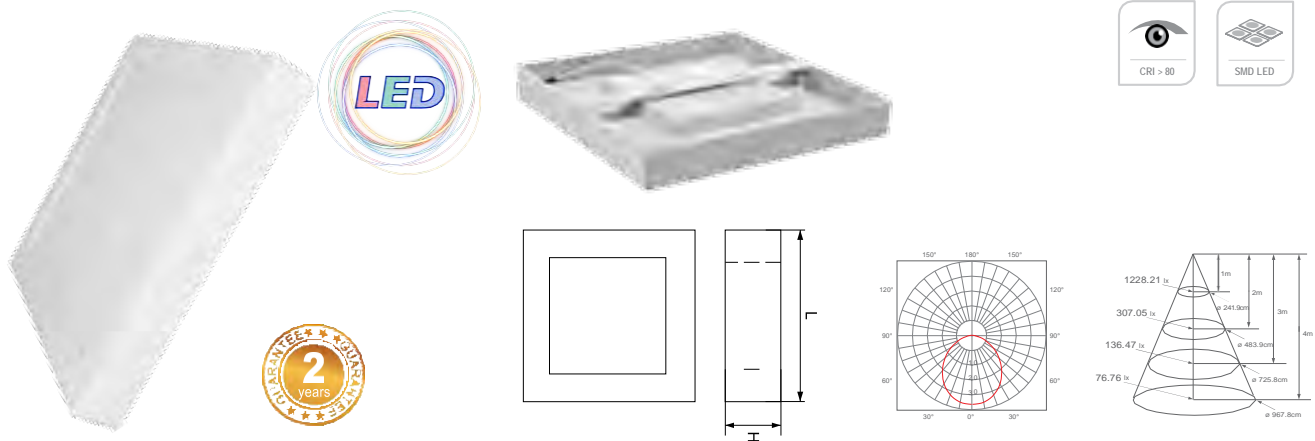

Code	Model no.	Input voltage (V)	Nomial Power (W)	Color Temp. (K)	Power factor	Lumen (Lm)	CRI (Ra)	Beam angle (°)	Life (hrs)	Dimensions (mm)	Quantity (pcs/ctn)
490685-4	HY/LED/SSLP/PC/6W/4000K	100-240VAC	6W	4000K	0.9	450	≥80	120°	40000	120x120mm	1/60
49068541	HY/LED/SSLP/PC/6W/6500K	100-240VAC	6W	6500K	0.9	450	≥80	120°	40000	120x120mm	1/60
490685-5	HY/LED/SSLP/PC/12W/4000K	100-240VAC	12W	4000K	0.9	960	≥80	120°	40000	168x168mm	1/40
49068551	HY/LED/SSLP/PC/12W/6500K	100-240VAC	12W	6500K	0.9	960	≥80	120°	40000	168x168mm	1/40
490685-6	HY/LED/SSLP/PC/18W/4000K	100-240VAC	18W	4000K	0.9	1440	≥80	120°	40000	225x225mm	1/20
49068561	HY/LED/SSLP/PC/18W/6500K	100-240VAC	18W	6500K	0.9	1440	≥80	120°	40000	225x225mm	1/20
490685-7	HY/LED/SSLP/PC/24W/4000K	100-240VAC	24W	4000K	0.9	1920	≥80	120°	40000	298x298mm	1/10
49068571	HY/LED/SSLP/PC/24W/6500K	100-240VAC	24W	6500K	0.9	1920	≥80	120°	40000	298x298mm	1/10

# CEILING ED LIGHT



## Led Ceiling Lamp ROUND

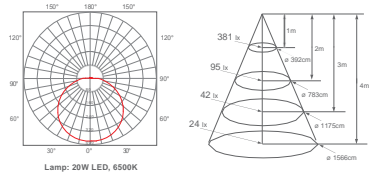
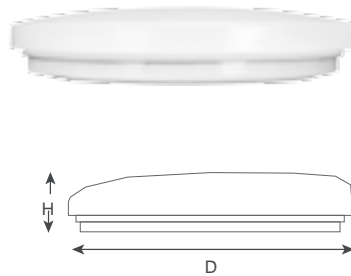

Code	Model no.	Input Voltage (V)	Nominal Power (W)	Color Temperature (K)	IP	Lumen (lm)	CRI (Ra)	Beam angle (°)	Life (hrs)	Dimensions (mm)	Quantity (pcs/ctn)
490740	HY/LED/14W/5000K	220-240VAC	14W	5000K	IP20	1200	≥80	120°	25000	Ø230	1/20
490740-1	HY/LED/20W/5000K	220-240VAC	20W	5000K	IP20	1700	≥80	120°	25000	Ø260	1/10
490740-2	HY/LED/24W/5000K	220-240VAC	24W	5000K	IP20	2250	≥80	120°	25000	Ø300	1/10
490740-21	HY/LED/32W/5000K	220-240VAC	32W	5000K	IP20	2880	≥80	120°	25000	Ø350	1/10
490740-22	HY/LED/42W/5000K	220-240VAC	42W	5000K	IP20	3570	≥80	120°	25000	Ø450	1/5

## Led Ceiling Lamp SQUARE

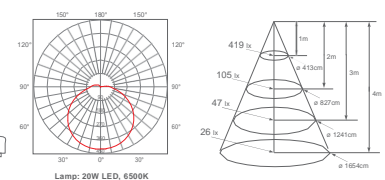
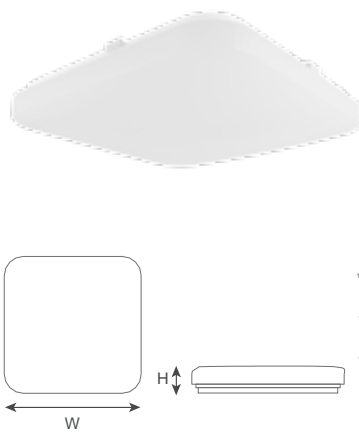

Code	Model no.	Input Voltage (V)	Nominal Power (W)	Color Temperature (K)	IP	Lumen (lm)	CRI (Ra)	Beam angle (°)	Life (hrs)	Dimensions (mm)	Quantity (pcs/ctn)
490740-3	HY/LED/SQ/20W/4000K	220-240VAC	20W	4000K	IP20	1700	≥80	120°	25000	280 X 280	1/10
490740-4	HY/LED/SQ/32W/4000K	220-240VAC	32W	4000K	IP20	2880	≥80	120°	25000	330 X 330	1/10
490740-5	HY/LED/SQ/42W/4000K	220-240VAC	42W	4000K	IP20	3570	≥80	120°	25000	430 X 430	1/5

## Led ceiling lamp STAR

A++ A IP20 RoHS EMC CE

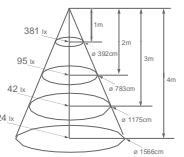
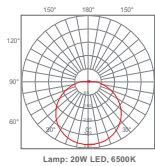
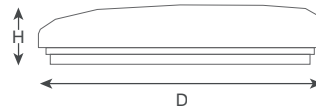

Code	Model no.	Input Voltage (V)	Nominal Power (W)	Color Temperature (K)	IP	Lumen (lm)	CRI (Ra)	Beam angle (°)	Life (hrs)	Dimensions (mm)	Quantity (pcs/ctn)
490740-8	HY/LED/24W/STAR/4000K	220-240VAC	24W	4000K	IP20	2600lm	≥80	120°	25000	Ø300	1/10
490740-9	HY/LED/32W/STAR/4000K	220-240VAC	32W	4000K	IP20	2600lm	≥80	120°	25000	Ø350	1/10

## Led Ceiling Light DONUT

A++ A IP20 RoHS EMC CE

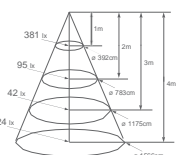
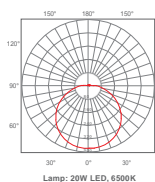

Code	Model no.	Input Voltage (V)	Nominal Power (W)	Color Temperature (K)	IP	Lumen (lm)	CRI (Ra)	Beam angle (°)	Life (hrs)	Dimensions (mm)	Quantity (pcs/ctn)
490740-6	HY/LED/20W/DONUT/4000K	220-240VAC	20W	4000K	IP20	1500lm	≥80	120°	25000	Ø300	1/5
490740-7	HY/LED/32W/DONUT/4000K	220-240VAC	32W	4000K	IP20	2500lm	≥80	120°	25000	Ø350	1/5

## Led Ceiling Light RING

A++ A IP 20 RoHS EMC F CE



Code	Model no.	Input Voltage (V)	Nominal Power (W)	Color Temperature (K)	IP	Lumen (lm)	CRI (Ra)	Beam angle (*)	Life (hrs)	Dimensions (mm)	Quantity (pcs/ctn)
490742-4	HY/LED/24W/PMR/4000K	220-240VAC	24W	4000K	IP20	1440lm	≥80	120°	25000	Ø300	1/5
490742-5	HY/LED/32W/PMR/4000K	220-240VAC	32W	4000K	IP20	1920lm	≥80	120°	25000	Ø350	1/5

## Led Ceiling Lamp SQUARE LINE

A++ A IP 20 RoHS EMC F CE



Code	Model no.	Input Voltage (V)	Nominal Power (W)	Color Temperature (K)	IP	Lumen (lm)	CRI (Ra)	Beam angle (*)	Life (hrs)	Dimensions (mm)	Quantity (pcs/ctn)
490740-51	HY/LED/SQ/SR/32W/4000K	220-240VAC	32W	4000K	IP20	2880	≥80	120°	25000	330 X 330	1/10
490740-52	HY/LED/SQ/SR/42W/4000K	220-240VAC	42W	4000K	IP20	3570	≥80	120°	25000	430 X 430	1/5

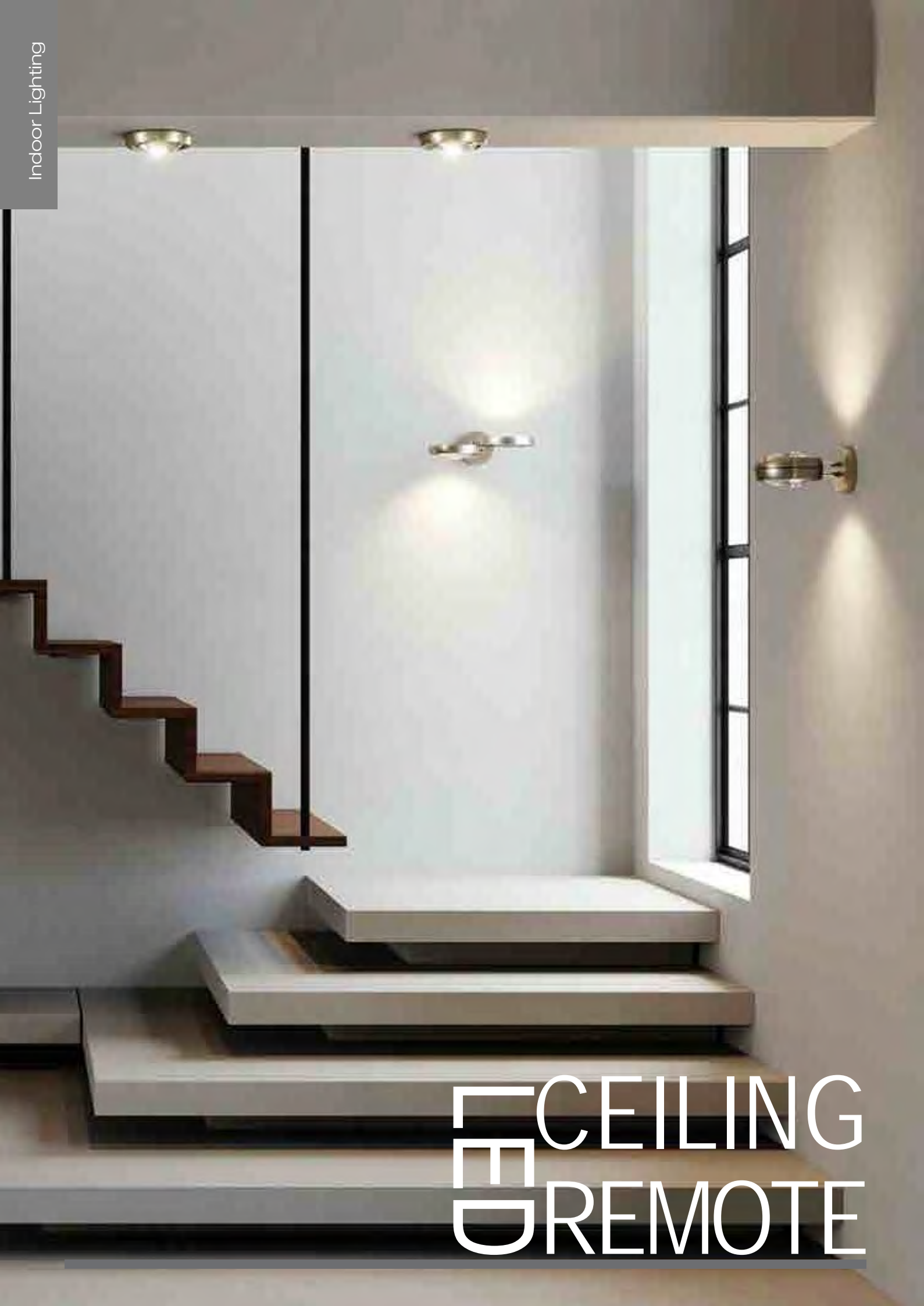

CEILING  
REMOTE



# Led Ceiling Light STAR DIMM

A++ A IP 20 RoHS EMC F CE

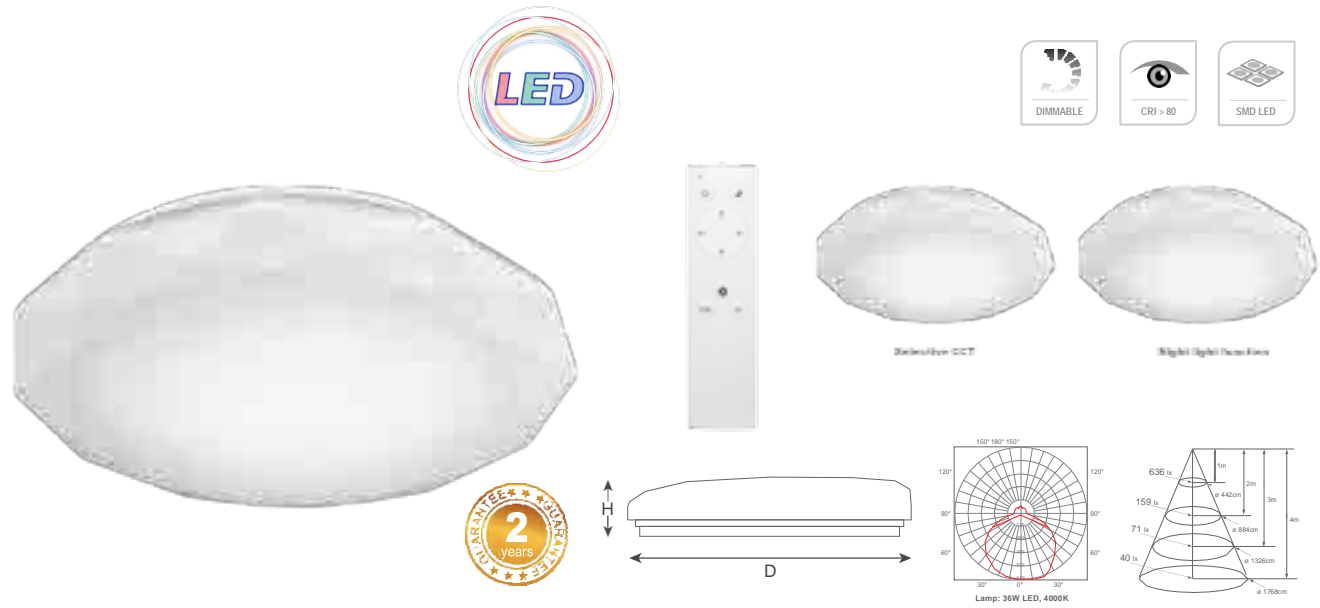

Code	Model no.	Input Voltage (V)	Nominal Power (W)	Color Temperature (K)	IP	Lumen (lm)	CRI (Ra)	Beam angle (°)	Life (hrs)	Dimensions (mm)	Quantity (pcs/ctn)
490742-6	HY/LED/36W/IR/DIMM/CCT	220-240VAC	36W	CCT	IP20	3250lm	≥80	120°	25000	Ø350	1/10

# Led Ceiling Light MOON DIMM

A++ A IP 20 RoHS EMC F CE



Code	Model no.	Input Voltage (V)	Nominal Power (W)	Color Temperature (K)	IP	Lumen (lm)	CRI (Ra)	Beam angle (°)	Life (hrs)	Dimensions (mm)	Quantity (pcs/ctn)
490742-3	HY/LED/32W/IR/CCT	220-240VAC	36W	CCT	IP20	3250lm	≥80	120°	25000	Ø450	1/5

# LED SENSOR LIGHT

## Led Wall Fixture with Movement Sensor

A++ A IP54 RoHS EMC F CE

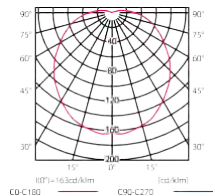
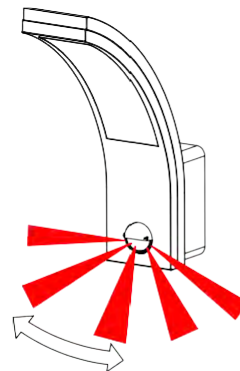
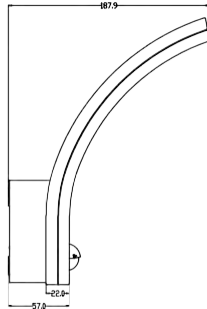
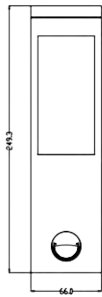

Code	Model no.	Input Voltage (V)	Nominal Power (W)	IP	Detection Distance (max/m)	Time Delay	Ambient Light	Product Size (ØxH)	Color	Material	Quantity (pcs/ctn)
490672-6	HY/ST53B/15W/W	220-240VAC	15W	IP54	max 9m	10 sec ± 3sec to 5 min ± 1min	>3-2000LUX	255x66x188mm	white	PC	1/10

## Led Wall Fixture with Movement Sensor

A++ A IP54 RoHS EMC F CE

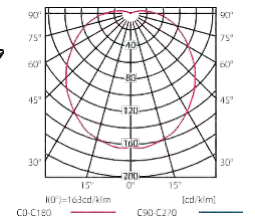
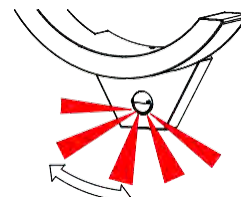
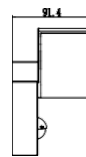
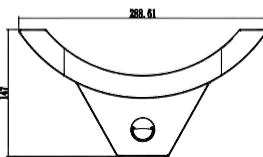

Code	Model no.	Input Voltage (V)	Nominal Power (W)	IP	Detection Distance (max/m)	Time Delay	Ambient Light	Product Size (ØxH)	Color	Material	Quantity (pcs/ctn)
490672-7	HY/ST54B/15W/W	220-240VAC	15W	IP54	max 9m	10 sec ± 3sec to 5 min ± 1min	>3-2000LUX	289x99x147mm	white	PC	1/10

## LED Ligh. Fix. with Movement Sensor

A++ A IP44 RoHS EMC F CE

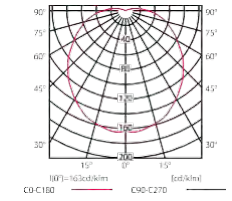
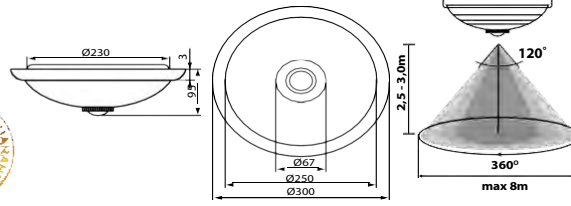

Code	Model no.	Input Voltage (V)	Nominal Power (W)	IP	Detection Distance (max/m)	Time Delay	Ambient Light	Product Size (ØxH)	Color	Material
490672-1	HY/LED/IP/12W/W	220-240VAC	12W	IP44	1-6m(radius)	3 sec ± 3sec to 3 min ± 30 sec	3-2000LUX	Ø290x100	white	metal/glass
490672-2	HY/LED/IP/16W/W	220-240VAC	16W	IP44	1-6m(radius)	3 sec ± 3sec to 3 min ± 30 sec	3-2000LUX	Ø290x100	white	metal/glass

## Lighting Fixture with Movement Sensor

A++ A IP20 RoHS EMC F CE

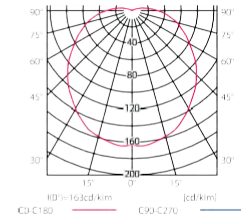
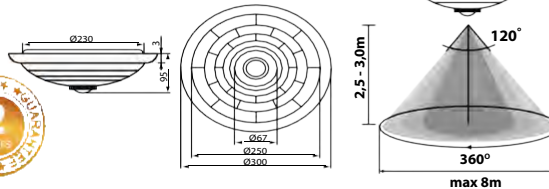

Code	Model no.	Input Voltage (V)	Nominal Power (W)	IP	Detection Distance (max/m)	Time Delay	Ambient Light	Product Size (ØxH)	Color	Material
490672	HY/PSL/360/W	220-240VAC	2x40W	IP20	max 6m	10 sec ± 3sec to 3 min ± 30sec	3-2000LUX	Ø230x125	white	metal/glass

## Lighting Fixture with Microwave Sensor

A++ A IP44 RoHS EMC F CE

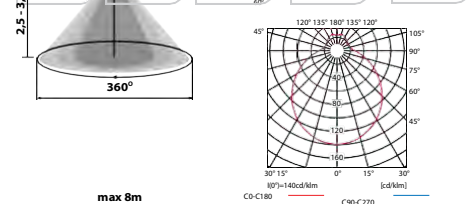
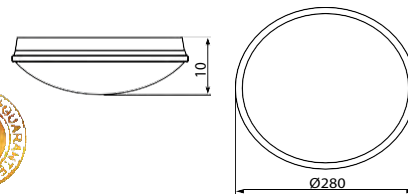
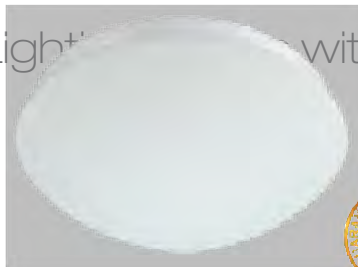

Code	Model no.	Input Voltage (V)	Power (W)	IP	Detection Distance (max/m)	Time Delay	Ambient Light	Product Size (ØxH)	Color	Material	Quantity (pcs/ctn)
490674	HY/MW/ST702/360/W	220-240VAC	60W	IP44	1-8m(radius)	10 sec ± 3sec to 12 min ± 1min	<3-	Ø280x100	white	metal/glass	1/5

## Lighting Fixture with Microwave Sensor

A++ A IP20 RoHS EMC F CE

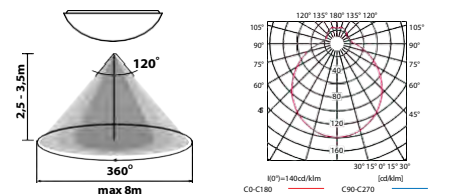
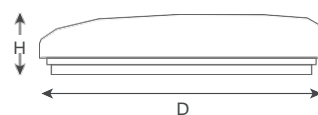

Code	Model no.	Input Voltage (V)	Power (W)	IP	Detection Distance (max/m)	Time Delay	Ambient Light	Product Size (ØxH)	Color	Material	Quantity (pcs/ctn)
490672-3	HY/LED/MW/20W/5000K	220-240VAC	18W	IP20	1-8m(radius)	30 sec ± 3sec	>3-2000LUX	Ø300	white	metal/PC	1/10



LED DOWN  
LED LIGHT

## Cob Led Downlights

A++ A IP 40 RoHS EMC F CE

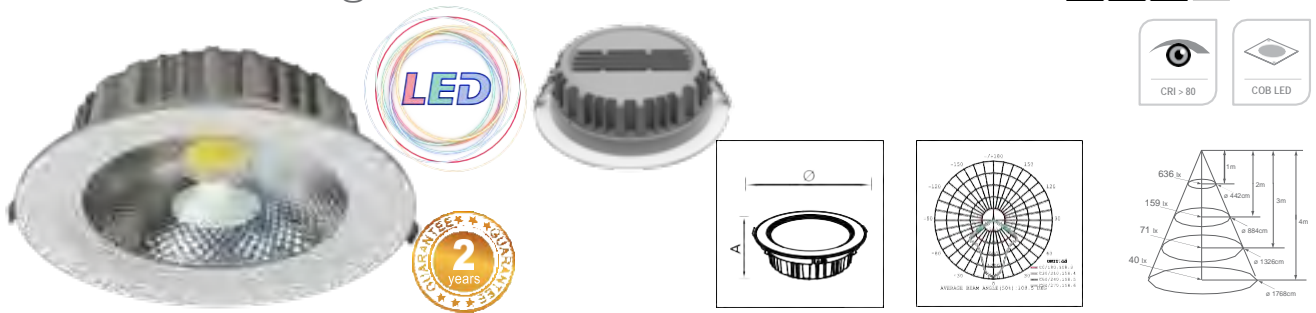

Code	Model no.	Input Voltage (V)	Nominal Power (W)	Color Temperature (K)	IP	Lumen (lm)	CRI (Ra)	Beam angle	Life (hrs)	Dimensions (mm)	Cut Out (mm)	Quantity (pcs/ctn)
490660	HY/LED/DW/15W/4000K	220-240VAC	15W	4000K	IP40	1050 lm	≥80	120°	50,000	Ø180x75	Ø160	1/30
490661	HY/LED/DW/20W/4000K	220-240VAC	20W	4000K	IP40	1500 lm	≥80	120°	50,000	Ø196x75	Ø175	1/24
490667	HY/LED/DW/30W/4000K	220-240VAC	30W	4000K	IP40	2300 lm	≥80	120°	50,000	Ø240x75	Ø215	1/10

## Power led Spotlights

A++ A IP 40 RoHS EMC F CE

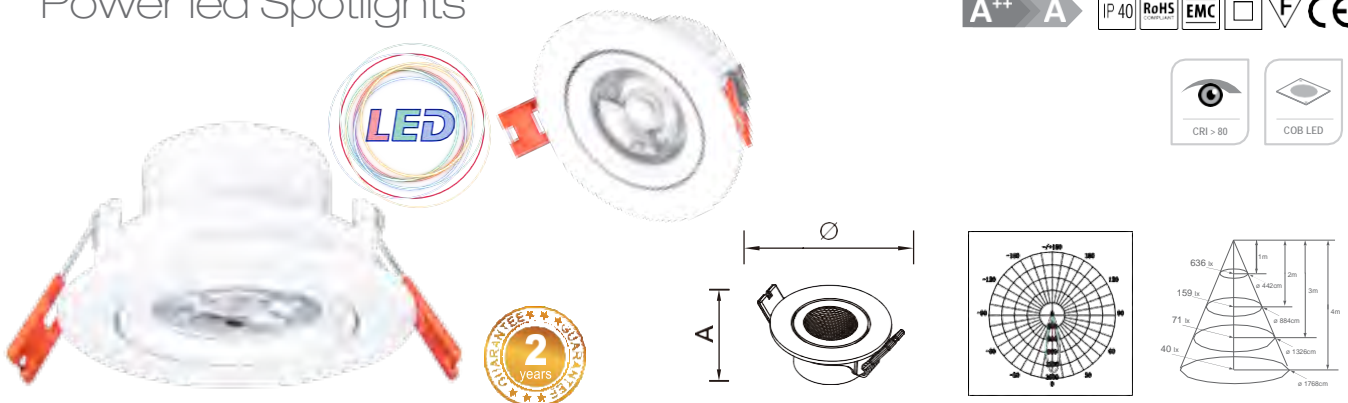

Code	Model no.	Input voltage (V)	Nominal Power (W)	Color Temp. (K)	IP	Lumen (Lm)	CRI (Ra)	Beam angle (°)	Life (hrs)	Dimensions (mm)	Cut Out (mm)	Quantity (pcs/ctn)
490666-1	HY/LED/DL/5W/4000K	220-240VAC	5W	4000K	IP40	450 lm	≥80	120°	30000	Ø85x48mm	Ø75	1/20
490666-2	HY/LED/DL/7W/4000K	220-240VAC	7W	4000K	IP40	630 lm	≥80	120°	30000	Ø85x48mm	Ø75	1/20

## Fixed Spot Downlight, without base

A++ A IP 40 RoHS EMC F CE



Code	Model no.	Input voltage (V)	Lamp	Base	Dimensions (mm)	Cut Out (mm)	Color	Material	Quantity (pcs/ctn)
490570	HY/DL/F/AL/WH	220-240VAC	MR16	without base	Ø80x25mm	Ø64	white	die cast aluminium	1/100
490572	HY/DL/F/AL/NM	220-240VAC	MR16	without base	Ø80x25mm	Ø64	nickel-mat	die cast aluminium	1/100

## Flexible Spot Downlight, without base

A++ A IP 40 RoHS EMC F CE



Code	Model no.	Input voltage (V)	Lamp	Base	Dimensions (mm)	Cut Out (mm)	Color	Material	Quantity (pcs/ctn)
490573	HY/DL/R/AL/WH	220-240VAC	MR16	without base	Ø85x25mm	Ø75	white	die cast aluminium	1/100
490575	HY/DL/R/AL/NM	220-240VAC	MR16	without base	Ø85x25mm	Ø75	nickel-mat	die cast aluminium	1/100



## Cob Led Track Luminaire 12W

A++ A IP20 RoHS EMC F CE

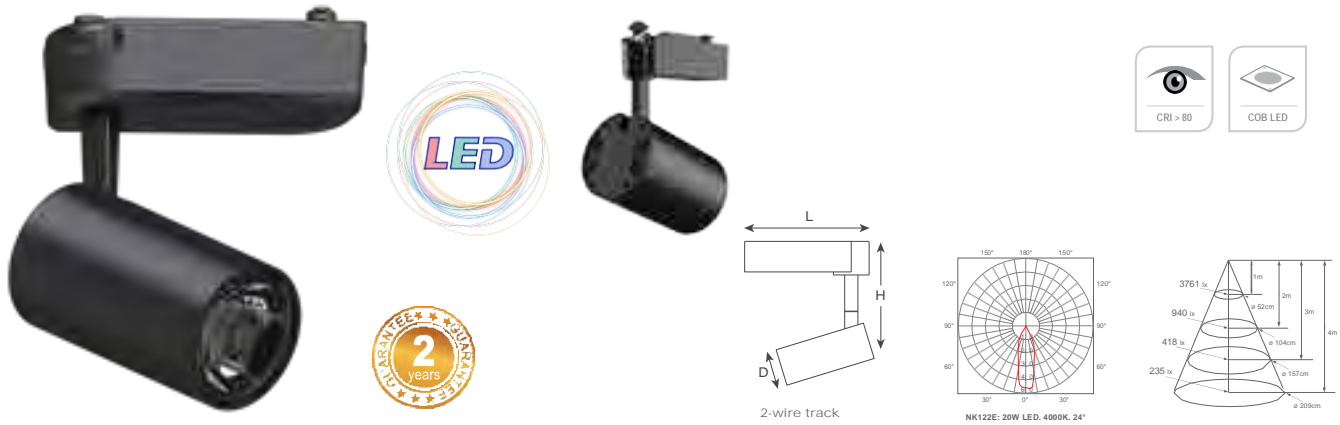

Code	Model no.	Voltage (V)	Power (W)	Color Temperature (K)	IP	Lumen (lm)	CRI (Ra)	Beam angle (°)	Life (hrs)	Color	Dimensions (mm)	Quantity (pcs/ctn)
490580-1	HY/CLT/12W/3000K/B	220-240VAC	12W	3000K	IP20	1020	≥80	120°	30000	black	Ø70x145mm	1/10
490581-1	HY/CLT/12W/4000K/B	220-240VAC	12W	4000K	IP20	1020	≥80	120°	30000	black	Ø70x145mm	1/10

## Cob Led Track Luminaire 30W

A++ A IP20 RoHS EMC F CE

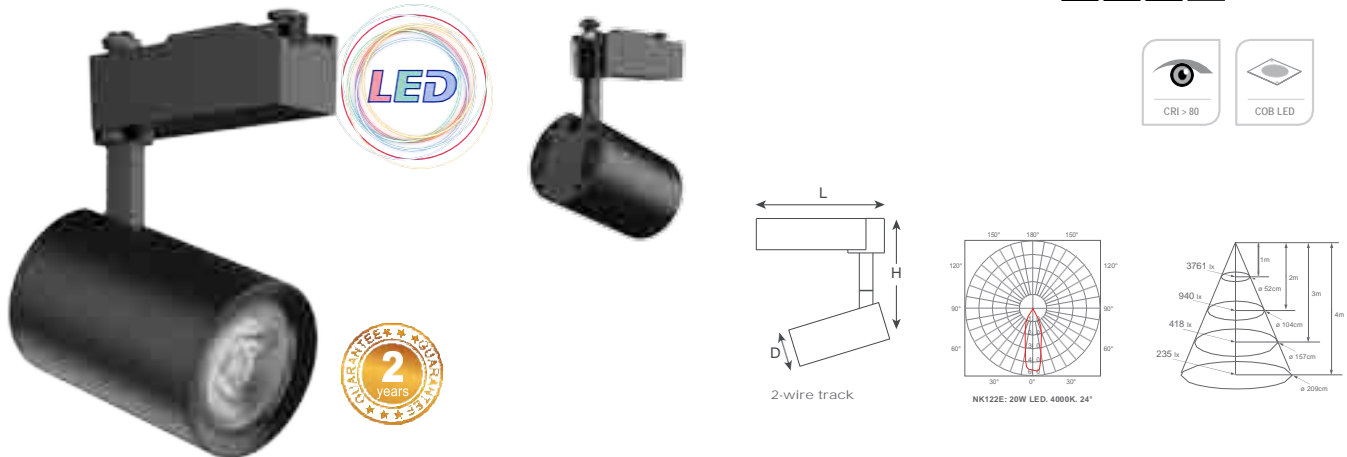

Code	Model no.	Voltage (V)	Power (W)	Color Temperature (K)	IP	Lumen (lm)	CRI (Ra)	Beam angle (°)	Life (hrs)	Color	Dimensions (mm)	Quantity (pcs/ctn)
490582-1	HY/CLT/30W/3000K/B	220-240VAC	30W	3000K	IP20	2550	≥80	120°	30000	black	Ø88x145mm	1/10
490583-1	HY/CLT/30W/4000K/B	220-240VAC	30W	4000K	IP20	2550	≥80	120°	30000	black	Ø55x145mm	1/10

## Accessories

### Tracks

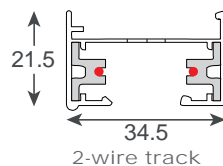
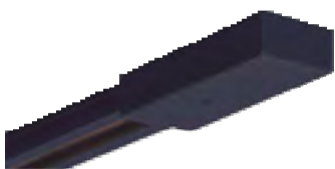

Code	Model no.	Input Voltage (V)	Color
490592-1	HY/TA/1m/B	220-240VAC	black
490594-1	HY/TA/2m/B	220-240VAC	black

### Central connector

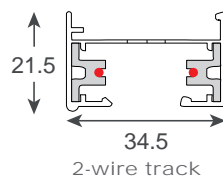

Code	Model no.	Input Voltage (V)	Color
490595-1	HY/TA/CC/B	220-240VAC	black

### 90° joint

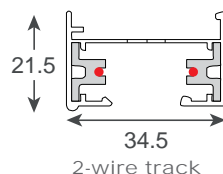

Code	Model no.	Input Voltage (V)	Color
490596-1	HY/TA/90J/B	220-240VAC	black



# LED TRACK LIGHT





## Cob Led Track Luminaire

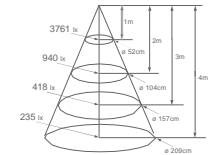
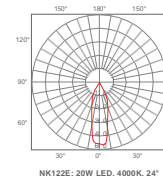
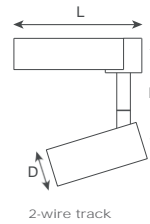

Code	Model no.	Voltage (V)	Power (W)	Color Temperature (K)	IP	Lumen (lm)	CRI (Ra)	Beam angle (°)	Life (hrs)	Color	Dimensions (mm)	Quantity (pcs/ctn)
490597	HY/CLT/2515T/20W/4000K/W	220-240VAC	20W	4000K	IP20	2400 lm	≥80	120°	40000	white	Ø88x155mm	1/30
490599	HY/CLT/2515T/30W/4000K/W	220-240VAC	30W	4000K	IP20	2400 lm	≥80	120°	40000	white	Ø88x155mm	1/30

## Cob Led Track Luminaire

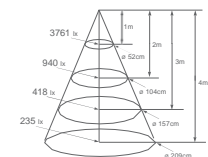
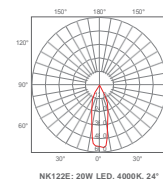
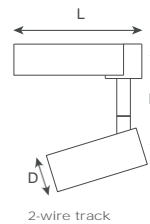

Code	Model no.	Input Voltage (V)	Power (W)	Color Temperature (K)	IP	Lumen (lm)	CRI (Ra)	Beam angle (°)	Life (hrs)	Color	Dimensions (mm)	Quantity (pcs/ctn)
490591-1	HY/CLT/053T/30W/4000K/W	220-240VAC	30W	4000K	IP20	2400 lm	≥80	120°	40000	white	Ø70x100mm	1/120

## Accessories

### Tracks

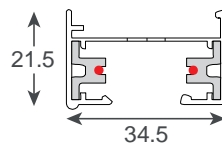

Code	Model no.	Input Voltage (V)	Color
490592	HY/TA/1m/W	220-240VAC	white
490594	HY/TA/2m/W	220-240VAC	white

### Central connector

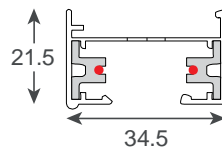

Code	Model no.	Input Voltage (V)	Color
490595	HY/TA/CC/W	220-240VAC	white

### 90° joint

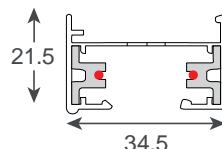

Code	Model no.	Input Voltage (V)	Color
490596	HY/TA/90J/W	220-240VAC	white



# EFBATTEN D LUMINAIRE

## LED Batten Luminaire

A++ A IP20 RoHS EMC F CE

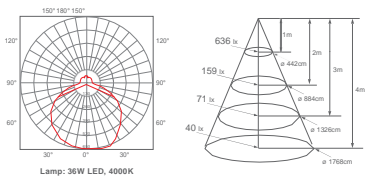

Code	Model no.	Voltage (V)	Power (W)	IP	Lumen (lm)	Color Temp.(K)	CRI (Ra)	Life (hrs)	Product Size (LxWxH)	Color (Body/ Difuzor)	Material	Quantity (pcs/ctn)
490380	HY/LED/BF/0.6/27W/4000K	220-240VAC	27W	IP20	2310 lm	4000K	≥80	30000	600x75x20mm	white/opal	ST/PC	1/25
490381	HY/LED/BF/0.6/27W/6500K	220-240VAC	27W	IP20	2310 lm	6500K	≥80	30000	600x75x20mm	white/opal	ST/PC	1/25
490382	HY/LED/BF/1.2/54W/4000K	220-240VAC	54W	IP20	5310 lm	4000K	≥80	30000	1200x75x20mm	white/opal	ST/PC	1/25
490383	HY/LED/BF/1.2/54W/6500K	220-240VAC	54W	IP20	5310 lm	6500K	≥80	30000	1200x75x20mm	white/opal	ST/PC	1/25

## LED Luminaire

A++ A IP20 RoHS EMC F CE

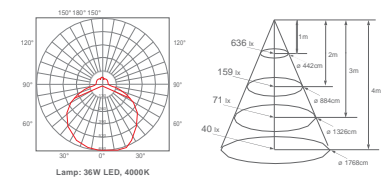
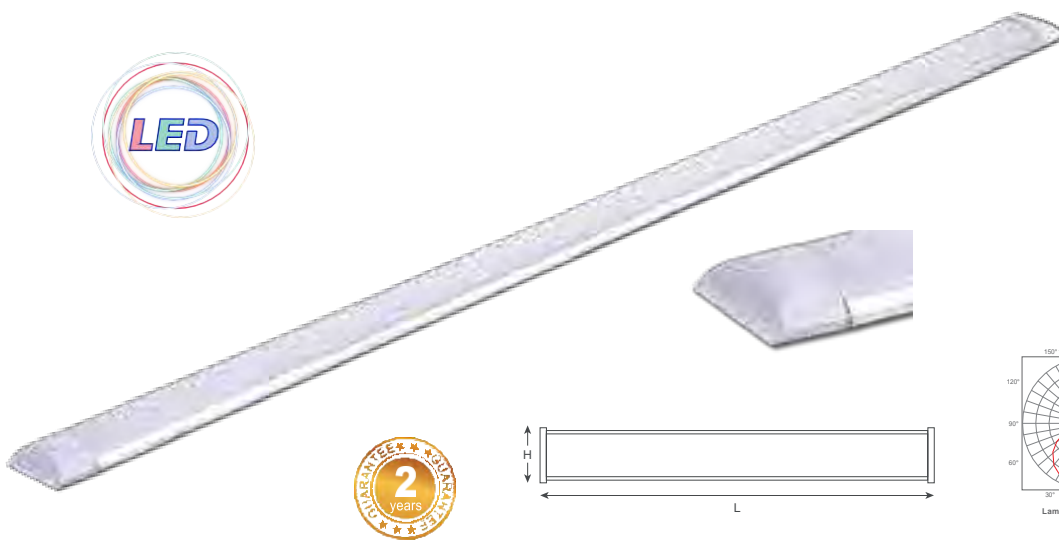

Code	Model no.	Voltage (V)	Power (W)	IP	Lumen (lm)	Color Temp.(K)	CRI (Ra)	Life (hrs)	Product Size (LxWxH)	Color (Body/ Difuzor)	Material	Quantity (pcs/ctn)
490378	HY/LED/1.2/FP/40W/6500K	220-240V	40W	IP20	3200 lm	6500K	≥80	30000	1210x75x25mm	grey/opal	AL/PC	1/20
490378-1	HY/LED/1.2/FP/40W/4000K	220-240V	40W	IP20	3200 lm	4000K	≥80	30000	1210x75x25mm	grey/opal	AL/PC	1/20
490377	HY/LED/0.6/FP/20W/6500K	220-240V	20W	IP20	1600 lm	6500K	≥80	30000	605x75x25mm	grey/opal	AL/PC	1/20
490377-1	HY/LED/0.6/FP/20W/4000K	220-240V	20W	IP20	1600 lm	4000K	≥80	30000	605x75x25mm	grey/opal	AL/PC	1/20
490376	HY/LED/0.3/FP/40W/6500K	220-240V	10W	IP20	800 lm	6500K	≥80	30000	305x75x25mm	grey/opal	AL/PC	1/20
490376-1	HY/LED/0.3/FP/40W/4000K	220-240V	10W	IP20	800 lm	4000K	≥80	30000	305x75x25mm	grey/opal	AL/PC	1/20

# HYUNDAI

## LED T8 Ultrathin Batten - without tube



A++ A IP20 RoHS EMC F CE

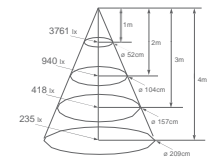
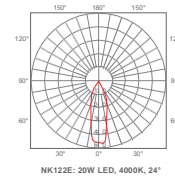
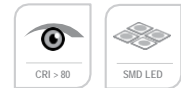

NK122E: 20W LED, 4000K, 24°

Code	Model no.	Voltage (V)	Power (W)	Color	IP	Color Temp.(K)	CRI (Ra)	Life (hrs)	Product Size (LxWxH)	Color (Body/ Difuzor)	Material	Quantity (pcs/ctn)
490584	HY/T8/UTB/1X0,6M	220-240VAC	1X0,6M	White	IP20	4000K	≥80	30000	600x75x20mm	white/opal	ST/PC	1/25
490585	HY/T8/UTB/1X1.2M	220-240VAC	1X1.2M	White	IP20	6500K	≥80	30000	600x75x20mm	white/opal	ST/PC	1/25
490586	HY/T8/UTB/1X1.5M	220-240VAC	1X1.5M	White	IP20	4000K	≥80	30000	1200x75x20mm	white/opal	ST/PC	1/25

## LED Linear Fixture

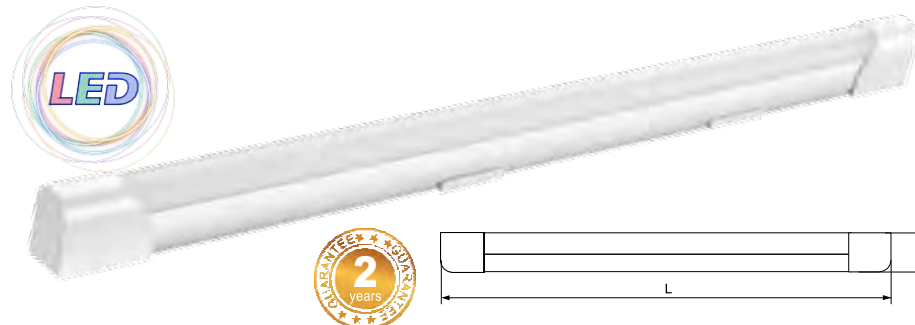

A++ A IP20 RoHS EMC F CE

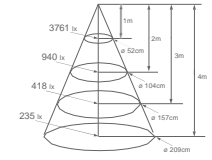
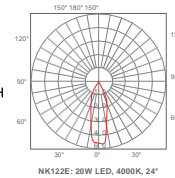
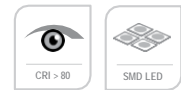

NK122E: 20W LED, 4000K, 24°

Code	Model no.	voltage (V)	Power (W)	Color Temp. (K)	IP	Lumen (Lm)	CRI (Ra)	Beam angle (°)	Life (hrs)	Product Size (LxWxH)
490860	HY/LED/L/10W/4000K	220-240VAC	10W	4000K	IP20	856	≥80	260°	30000	600x30x40mm
490861	HY/LED/L/20W/4000K	220-240VAC	20W	4000K	IP20	1700	≥80	260°	30000	1200x30x40mm

## Led Batten Fitting T5, with switch



A++ A IP20 RoHS EMC F CE

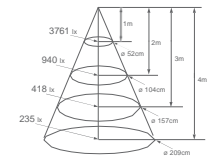
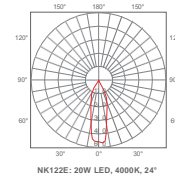

NK122E: 20W LED, 4000K, 24°

Code	Model no.	voltage (V)	Power (W)	Color Temp. (K)	IP	Lumen (Lm)	CRI (Ra)	Beam angle (°)	Life (hrs)	Product Size (LxWxH)	Quantity (pcs/ctn)
490587	HY/T5N/LED/8W/4000K	220-240VAC	8W	4000K	IP20	600 lm	≥80	320°	25000	600x22x33mm	1/25
490588	HY/T5N/LED/10W/4000K	220-240VAC	10W	4000K	IP20	800 lm	≥80	320°	25000	900x22x33mm	1/25
490589	HY/T5N/LED/14W/4000K	220-240VAC	14W	4000K	IP20	1100 lm	≥80	320°	25000	1200x22x33mm	1/25

## LED Cabinet rotatable Fixture

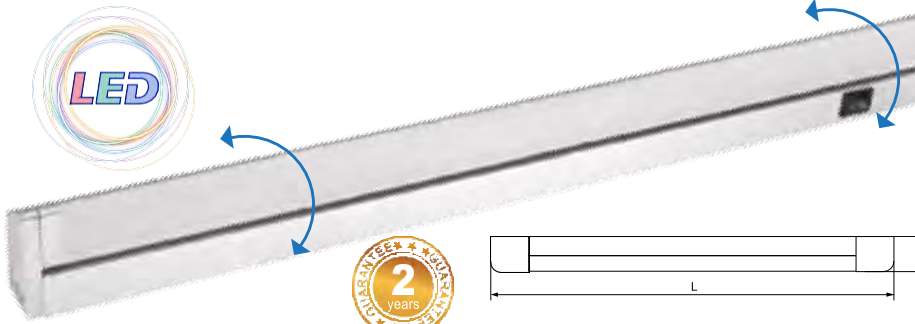

A++ A IP20 RoHS EMC F CE

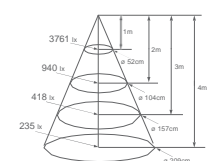
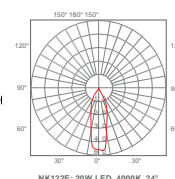
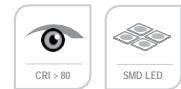

NK122E: 20W LED, 4000K, 24°

Code	Model no.	voltage (V)	Nomial Power (W)	Color Temp. (K)	IP	Lumen (Lm)	CRI (Ra)	Beam angle (°)	Life (hrs)	Product Size (LxWxH)
490862	HY/LED/C/10W/4000K	220-240VAC	10W	4000K	IP20	500	≥80	180°	30000	600x20x50mm
490863	HY/LED/C/14W/4000K	220-240VAC	14W	4000K	IP20	700	≥80	180°	30000	900x20x50mm



## Batten Fittings Ready for LED tube 1x

A++ A IP20 RoHS COMPLIANT EMC F CE

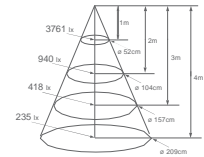
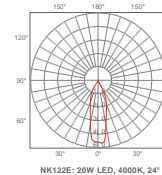
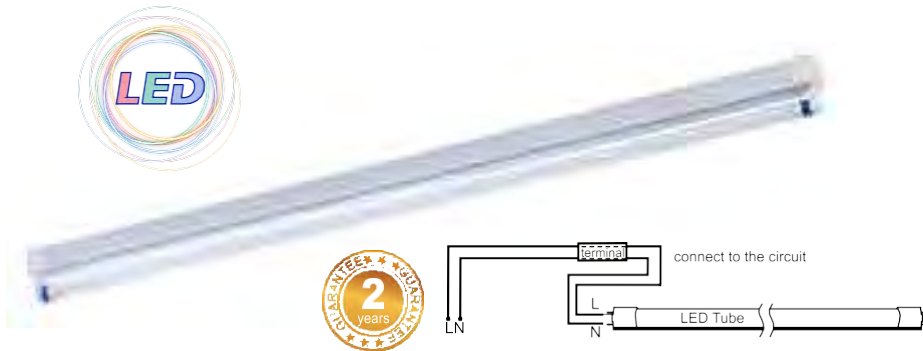

Code	Model no.	Input Voltage (V)	Nominal Power (W)	Ballast	IP	Product Size (LxWxH)	Color	Material	Quantity (pcs/ctn)
490350-1	HY/BRL/1x0.6M	220-240VAC	10W	/	IP20	620x50x85mm	white	metal sheet	1/10
490351-1	HY/BRL/1x1.2M	220-240VAC	20W	/	IP20	1230x50x85mm	white	metal sheet	1/10
490354-1	HY/BRL/1x1.5M	220-240VAC	24W	/	IP20	1530x50x85mm	white	metal sheet	1/10

## Batten Fittings Ready for LED tube 2x

A++ A IP20 RoHS COMPLIANT EMC F CE

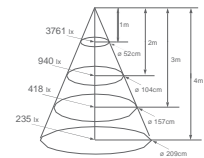
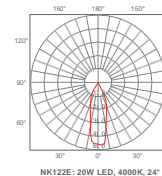
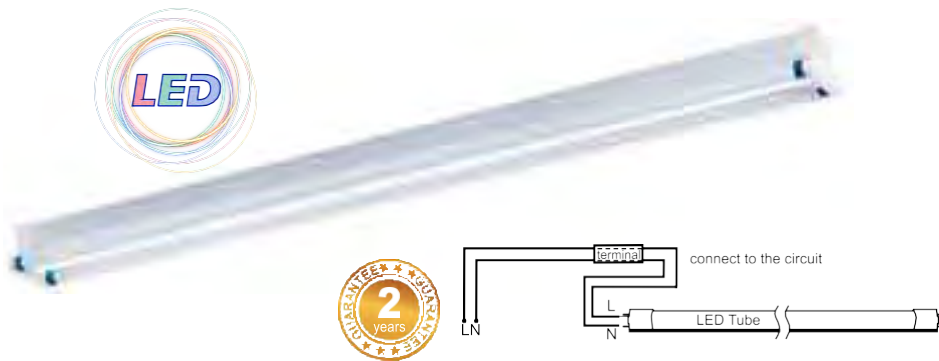

Code	Model no.	Input Voltage (V)	Nominal Power (W)	Ballast	IP	Product Size (LxWxH)	Color	Material	Quantity (pcs/ctn)
490352-1	HY/BRL/2x0.6M	220-240VAC	2x10W	/	IP20	620x100x85mm	white	metal sheet	1/10
490353-1	HY/BRL/2x1.2M	220-240VAC	2x20W	/	IP20	1230x100x85mm	white	metal sheet	1/10
490355-1	HY/BRL/2x1.5M	220-240VAC	2x24W	/	IP20	1530x100x85mm	white	metal sheet	1/10

## Batten Fittings Ready for LED tube 2x

A++ A IP20 RoHS COMPLIANT EMC F CE



Code	Model no.	Product Size (LxWxH)	Color	Material	Quantity (pcs/ctn)
490357	HY/SB/2x36W	1230x200x110mm	white	metal sheet	1/6
490359	HY/SB/2x58W	1530x200x110mm	white	metal sheet	1/6



# BATHROOM LED LIGHT

## LED Bathroom waterproof fixture White

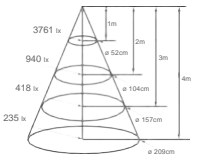
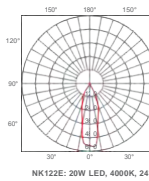
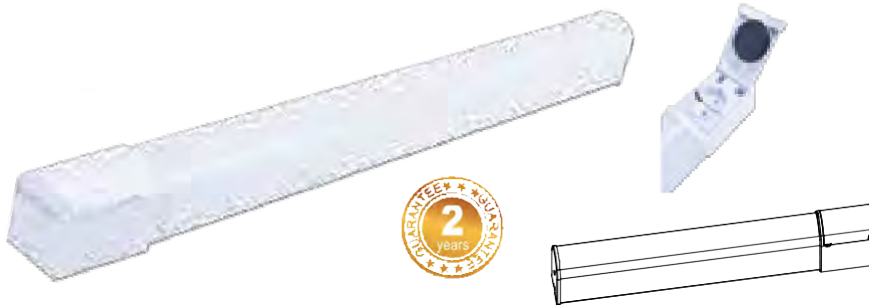

Code	Model no.	voltage (V)	Power (W)	Temp. (K)	IP	Lumen (Lm)	CRI (Ra)	Beam angle (°)	Life (hrs)	Color	Product Size (LxWxH)	Quantity (pcs/ctn)
490931	HY/W600S50-4/4000K/W	220-240VAC	15W	4000K	IP44	1240	≥80	133°	30000	White	682x59x66mm	1/20
490932	HY/W490S50-4/4000K/W	220-240VAC	8W	4000K	IP44	800	≥80	133°	30000	White	492x59x66mm	1/20

## LED Bathroom waterproof fixture Chrome

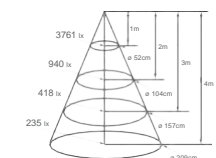
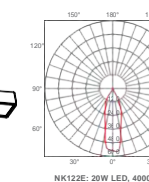
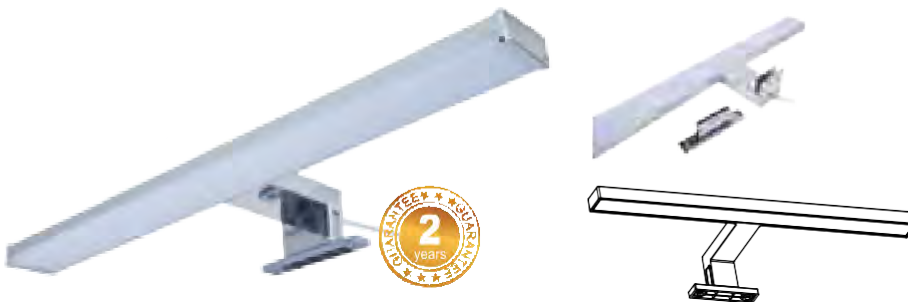
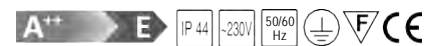

Code	Model no.	voltage (V)	Power (W)	Temp. (K)	IP	Lumen (Lm)	CRI (Ra)	Beam angle (°)	Life (hrs)	Color	Product Size (LxWxH)	Quantity (pcs/ctn)
490933	HY/W400C40-1B/4000K/C	220-240VAC	8W	4000K	IP44	640 lm	≥80	110°	30000	Chrom	400x112x44mm	1/20
490934	HY/W600C40-1B/4000K/C	220-240VAC	12W	4000K	IP44	960 lm	≥80	110°	30000	Chrom	600x112x44mm	1/20

## LED Bathroom waterproof fixture Chrome

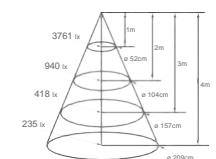
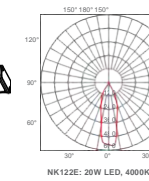
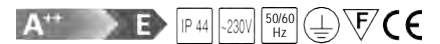

Code	Model no.	voltage (V)	Power (W)	Temp. (K)	IP	Lumen (Lm)	CRI (Ra)	Beam angle (°)	Life (hrs)	Color	Product Size (LxWxH)	Quantity (pcs/ctn)
490935	HY/W400C40-2/4000K/C	220-240VAC	8W	4000K	IP44	640 lm	≥80	110°	30000	Chrom	400x112x42mm	1/20
490936	HY/W600C40-2/4000K/C	220-240VAC	12W	4000K	IP44	960 lm	≥80	110°	30000	Chrom	600x112x42mm	1/20

## LED Bathroom waterproof fixture Chrome

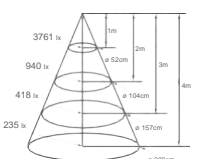
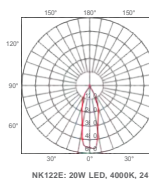
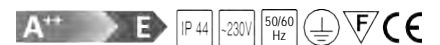

Code	Model no.	voltage (V)	Power (W)	Temp. (K)	IP	Lumen (Lm)	CRI (Ra)	Beam angle (°)	Life (hrs)	Color	Product Size (LxWxH)	Quantity (pcs/ctn)
490937	HY/W300C22/4000K/C	220-240VAC	5W	4000K	IP44	325 lm	≥80	110°	30000	Chrom	300x97x41mm	1/20

# WATERPROOF LED LUMINAIRE





## Waterproof LED Luminaire

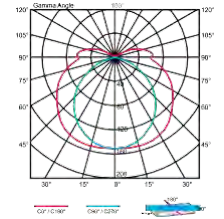
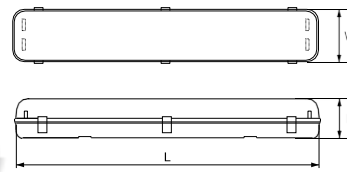

Code	Model no.	Input Voltage (V)	Nominal Power (W)	IP	Lumen (Lm)	Color Temp.(K)	CRI (Ra)	Led chip	Led Qty (pcs)	Life (hrs)	Product Size (LxWxH)	Color (Body/ Difuzor)	Material
490370	HY/LED/WP/20W	220-240V	20W	IP65	1800 lm	6000K	≥80	2835	56	30000	600x85x80mm	grey/opal	PC/PC
490371	HY/LED/WP/40W	220-240V	40W	IP65	3600 lm	6000K	≥80	2835	112	30000	1200x85x80mm	grey/opal	PC/PC
490732	HY/LED/WP/60W	220-240V	60W	IP65	4500 lm	6000K	≥80	2835	168	30000	1500x85x80mm	grey/opal	PC/PC

## Waterproof LED Luminaire DS

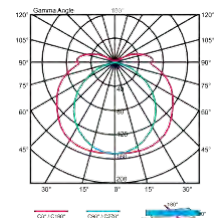
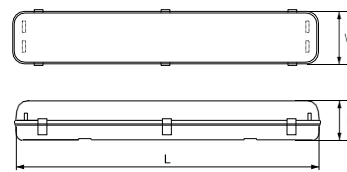

Code	Model no.	Input Voltage (V)	Power (W)	IP	Lumen (Lm)	Color Temp.(K)	CRI (Ra)	Led chip	Led Qty (pcs)	Life (hrs)	Product Size (LxWxH)	Color (Body/ Difuzor)	Material
490375	HY/LED/WP/DS/50W/6500K	220-240V	50W	IP65	3800 lm	6500K	≥80	2835	288	30000	1520x68x48mm	white/opal	PC/PC
490374	HY/LED/WP/DS/36W/6500K	220-240V	36W	IP65	3200 lm	6500K	≥80	2835	200	30000	1220x68x48mm	white/opal	PC/PC
490373	HY/LED/WP/DS/18W/6500K	220-240V	18W	IP65	1600 lm	6500K	≥80	2835	100	30000	610x68x48mm	white/opal	PC/PC



 WATERPROOF  
READY FOR TUBE

## Waterproof Luminaire Ready For LED Tube 1X

A++ B 230V 50/60 Hz T8 613

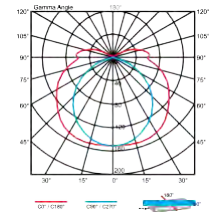
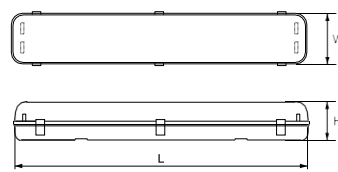

Code	Model no.	Input Voltage (V)	IP	Product Size (LxWxH)	Color (Body/Difuzor)	Material	Color (Body/Difuzor)	Material
490360-2	HY/WP/RFLED/1X0,6M	220-240VAC	IP65	660x135x94	grey/opal	PC/PC	grey/transparent	PC/PC
490362-2	HY/WP/RFLED/1X1,2M	220-240VAC	IP65	1268x135x94	grey/opal	PC/PC	grey/transparent	PC/PC
490364-2	HY/WP/RFLED/1X1,5M	220-240VAC	IP65	1562x135x94	grey/opal	PC/PC	grey/transparent	PC/PC

## Waterproof Luminaire Ready For LED Tube 2X

A++ B 230V 50/60 Hz T8 613

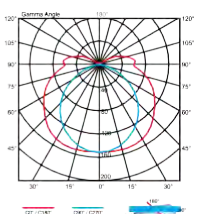
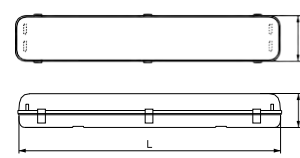

Code	Model no.	Input Voltage (V)	IP	Product Size (LxWxH)	Color (Body/Difuzor)	Material	Color (Body/Difuzor)	Material
490361-2	HY/WP/RFLED/2X0,6M	220-240VAC	IP65	660x135x94	grey/opal	PC/PC	grey/transparent	PC/PC
490363-2	HY/WP/RFLED/2X1,2M	220-240VAC	IP65	1268x135x94	grey/opal	PC/PC	grey/transparent	PC/PC
490365-2	HY/WP/RFLED/2X1,5M	220-240VAC	IP65	1562x135x94	grey/opal	PC/PC	grey/transparent	PC/PC

# STRIP LED LIGHT



## Led Strip 4.8W 12VDC

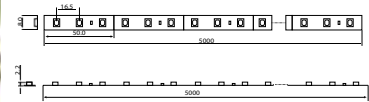
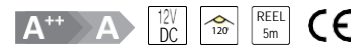

Code	Model no.	Input Voltage (V)	Nominal Power (W)	SMD Type	LED (qty)	Color Temperature (K)	IP	PCB length	length (m)	Packaging (qty/ctn)
490700	HY/LS/12V/3528/60/CW/IP20	12VDC	4.8W/m	3528	60	6000K	IP20	0,5 m	5 m	5/500 m
490701	HY/LS/12V/3528/60/WW/IP20	12VDC	4.8W/m	3528	60	3000K	IP20	0,5 m	5 m	5/500 m
490702	HY/LS/12V/3528/60/CW/IP67	12VDC	4.8W/m	3528	60	6000K	IP67	0,5 m	5 m	5/500 m

## Led Strip 7.2W 12VDC RGB

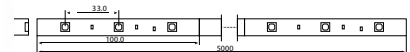
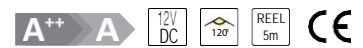

Code	Model no.	Input Voltage (V)	Nominal Power (W)	SMD Type	LED (qty)	Color Temperature (K)	IP	PCB length	length (m)	Packaging (qty/ctn)
490703	HY/LS/12V/5050/30/RGB/IP67	12VDC	7.2W/m	5050	30	RGB	IP67	0,5 m	5 m	5/500 m
490703-1	HY/LS/12V/5050/30/RGB/IP20	12VDC	7.2W/m	5050	30	RGB	IP20	0,5 m	5 m	5/500 m

## Led Strip 14.4W 12VDC

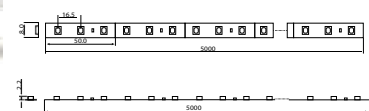
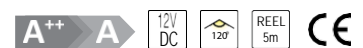

Code	Model no.	Input Voltage (V)	Nominal Power (W)	SMD Type	LED (qty)	Color Temperature (K)	IP	PCB length	length (m)	Packaging (qty/ctn)
490704	HY/LS/12V/5050/60/CW/IP20	12VDC	14.4W/m	5050	60	6000K	IP20	0,5 m	5 m	5/500 m
490705	HY/LS/12V/5050/60/WW/IP20	12VDC	14.4W/m	5050	60	3000K	IP20	0,5 m	5 m	5/500 m
490706	HY/LS/12V/5050/60/CW/IP67	12VDC	14.4W/m	5050	60	6000K	IP67	0,5 m	5 m	5/500 m

## Power Supply for Led Strips 12VDC

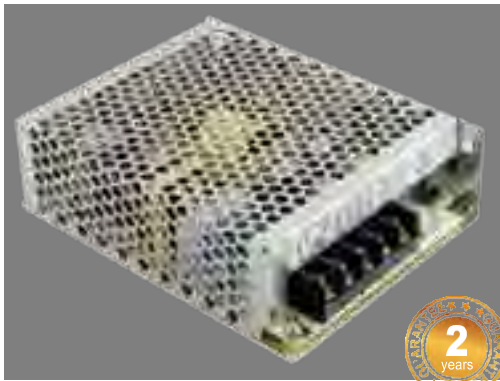
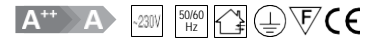

Code	Model no.	Input Voltage (V)	Output Voltage (V)	Maximum Power (W/A)	IP
490715	HY/PS/DC12V/15W/1,7A	220VAC	12VDC	15W/1,7A	20
490716	HY/PS/DC12V/25W/1,7A	220VAC	12VDC	25W/1,7A	20
490717	HY/PS/DC12V/36W/3,5A	220VAC	12VDC	36W/3,5A	20
490718	HY/PS/DC12V/60W/5A	220VAC	12VDC	60W/5A	20
490719	HY/PS/DC12V/120W/8,5A	220VAC	12VDC	120W/8,5A	20
490719-1	HY/PS/DC12V/150W/12,5A	220VAC	12VDC	150W/12,5A	20
490719-2	HY/PS/DC12V/200W/16,5A	220VAC	12VDC	200W/16,5A	20
490719-3	HY/PS/DC12V/360W/30A	220VAC	12VDC	360W/30A	20

## Wireless Controller for 12V RGB Led Strip

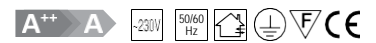

Code	Model no.	Max Power
490720	HY/TC/DC12V/3,6A/RGB	250W

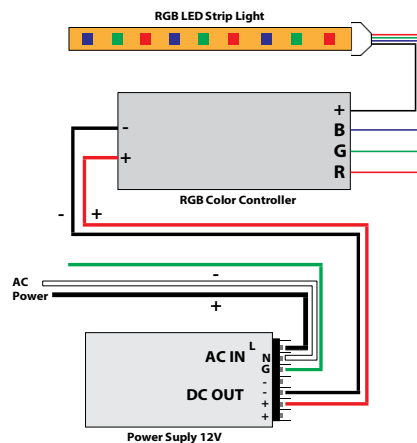

## Wireless Controller For 12v/24v Led Strip

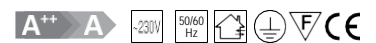

Code	Model no.	Max Power	Quantity (pcs/ctn)
490720-1	HY/TC/DC12V/3,6A/RGB	96W	1/100



## Aluminum Profiles Sets for Led Strip

A++ A 230V 50/60 Hz



Code	Model no.	Product Size (LxWxH)	Difuzor	Material
490581	HY/1203/2M	2000x18x18mm	Opal	Aluminum

## Aluminum Profiles Sets for Led Strip

A++ A 230V 50/60 Hz



Code	Model no.	Product Size (LxWxH)	Difuzor	Material
490583	HY/1102/2M	2000x15,9x6mm	Opal	Aluminum



EMERGENCY  
LED LAMP

---



## Emergency-Exit Wall Lamp

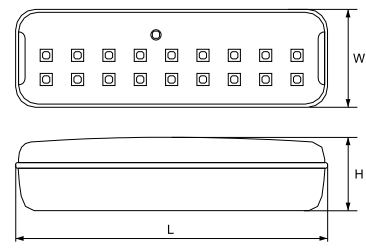

Code	Model no.	Input Voltage (V)	Battery (V/Ah)	LED no.	Charging Time	Duration	IP	Dimensions LxWxH (mm)	Quantity (pcs/ctn)
490012	HY/EM/W/1048	220V-240V	2 x 4V 800mAh	18	20 hours	4 hours	IP20	246x76x41mm	1/10

## Emergency-Exit Wall Lamp

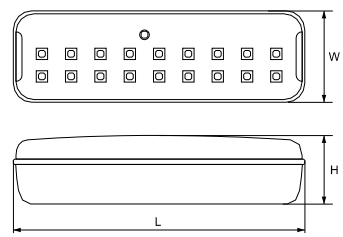

Code	Model no.	Input Voltage (V)	Battery (V/Ah)	LED no.	Charging Time	Duration	IP	Dimensions LxWxH (mm)	Quantity (pcs/ctn)
490013	HY/EM/W/8032	220V-240V	2 x 4V 800mAh	24	20 hours	4 hours	IP20	327x76x43mm	1/10

## Emergency Lamp Non Maintained

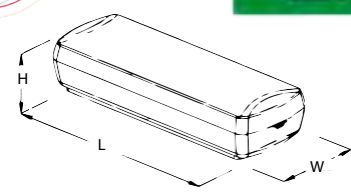

Code	Model no.	Input Voltage (V)	Battery (V/Ah)	LED no.	Charging Time	Duration	IP	Dimensions LxWxH (mm)	Quantity (pcs/ctn)
490014	HY/EM/W/7034	220V-240V	3.6V 600mAh	5 SMD 2.5W 170lm	15-24 hours	3 hours	IP20	255.x90x50,mm	1/30

## Emergency Lamp Non Maintained

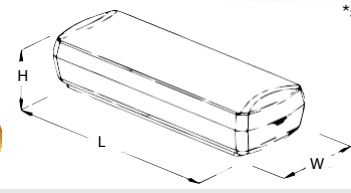
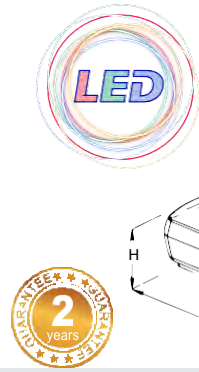
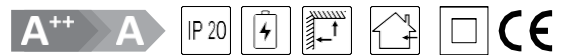

Code	Model no.	Input Voltage (V)	Battery (V/Ah)	LED no.	Charging Time	Duration	IP	Dimensions LxWxH (mm)	Quantity (pcs/ctn)
490015	HY/EM/W/7039B	220V-240V	2 x 4V 800mAh	6 SMD 3W 220lm	15-24 hours	3 hours	IP20	265x105.x50mm	1/40

## Led Torch

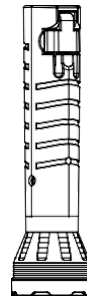
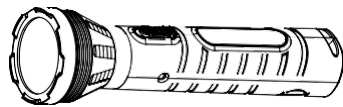

Code	Model no.	Nominal Power (W)	Battery (V/ Ah)	Duration	LED no.	Quantity (pcs/ctn)
490019	HY/4331	3W	4V 900mAh	Strong light 1h / Weak light 4h	1 Hi-Power	1/60

## Led Torch

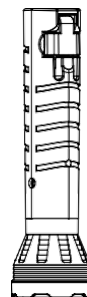
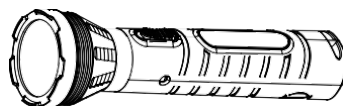

Code	Model no.	Nominal Power (W)	Battery (V/ Ah)	Duration	LED no.	Quantity (pcs/ctn)
490019-1	HY/4331	5W	4V 1200mAh	Strong light 1h / Weak light 4h	1 Hi-Power	1/40

## Led Torch

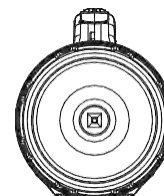
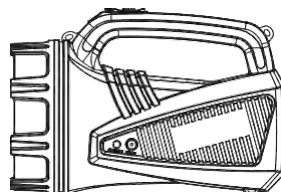

Code	Model no.	Nominal Power (W)	Battery (V/Ah)	Duration	LED no.	Quantity (pcs/ctn)
490023	HY/8195	5W	4V 6Ah	Strong light 4h / Weak light 16h	1 SMD	1/10

## Led Torch



Code	Model no.	Battery (V/ Ah)	LED no.	Quantity (pcs/ctn)
490017	HY/9032	1x4V 0.8Ah	9	1/48

## Led Torch



Code	Model no.	Battery (V/Ah)	LED no.	Quantity (pcs/ctn)
490018	HY/9044	1x4V 5Ah	19	1/8

## Emergency Lamp

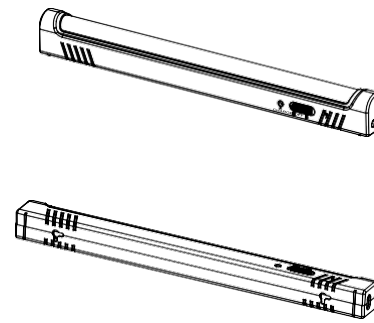

Code	Model no.	Nominal Power (W)	Battery (V/Ah)	Duration	LED no.	Quantity (pcs/ctn)
490020	HY/L8060	6W	3,7V 2000Ah LITHIUM	Strong light 0,7h / Weak light 3h	60 SMD	1/24

## Led Head Torch

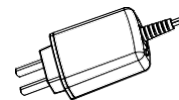
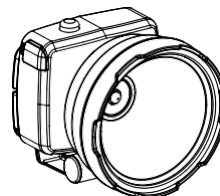

Code	Model no.	Nominal Power (W)	Battery (V/Ah)	Duration	LED no.	Quantity (pcs/ctn)
490022	HY/L5033	3W	3,7V 2000Ah LITHIUM	Strong light 3h / Weak light 12h	1 Hi-Power	1/100

## Emergency Lamp

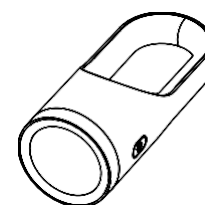

Code	Model no.	Nominal Power (W)	Battery (V/Ah)	Duration	LED no.	Quantity (pcs/ctn)
490021	HY/KN-L4342	3W	3.7V 1800Ah Lithium	Strong light 3h / Weak light 12h	19	1/60

## Camping Lamp

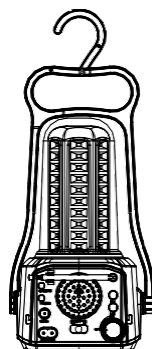

Code	Model no.	Nominal Power (W)	Battery (V/Ah)	Duration	LED no.	Quantity (pcs/ctn)
490024	HY/6862RDL	6W	4V 6Ah	Strong light 3h / Weak light 10h / Radio 4h	60 SMD	1/12

Indoor Lighting

# WORK CLAMP





## Work Lamp

A++ A CE



Code	Model no.	Input Voltage (V)	Nominal Power (W)	Cable	Cable length	Color	Quantity (pcs/ctn)
333991	HY/TW/10m/O	220V-240V	Max 60W	H05VV-F 2X0.75mm2	10 m	Orange	1/20
333991-1	HY/DY-YJD-A-1/5m/O	220V-240V	Max 60W	H05VV-F 2X0.75mm2	5 m	Orange	1/25

## Led Work Lamp

A++ A CE



Code	Model no.	Input Voltage (V)	Nominal Power (W)	Cable	Cable length	Color	Quantity (pcs/ctn)
333992	HY/YJD-A-5LP/5m	220V-240V	5W	H05VV-F 2X0.75mm2	5 m	Black	1/25

## Led Work Lamp

A++ A CE



Code	Model no.	Input Voltage (V)	Nominal Power (W)	Cable	Cable length	Color	Quantity (pcs/ctn)
333992-1	HY/YJD-A-5LP/5m	220V-240V	6W	H05VV-F 2X0.75mm2	5 m	Black	1/25

# FLOOD LIGHT

Outdoor Lighting

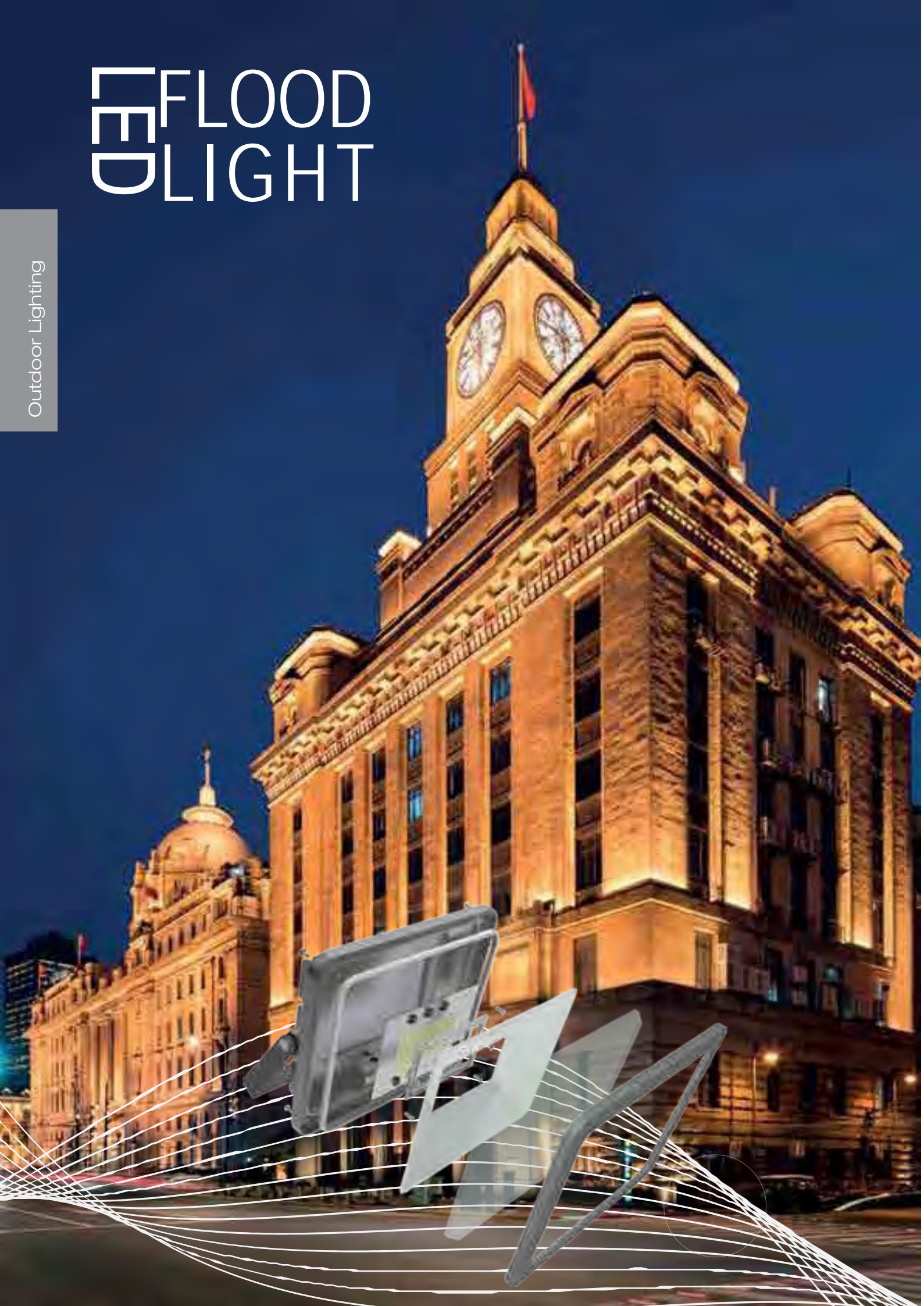

## Led Flood Light

A++ A IP65 Ra>80 30000h CE

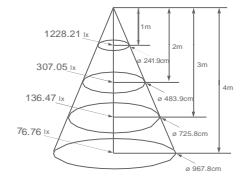
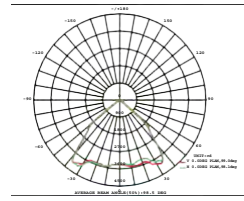
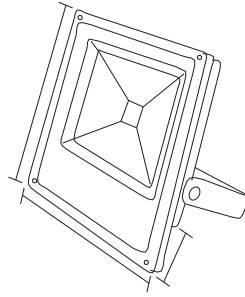

Code	Model no.	Voltage (V)	Power (W)	Temperature (K)	Luminous Flux (lm)	Power factor	CRI	LED Type	IP	Product Size (L/W/H)	Average Life (hrs)	Material	Quantity (pcs/ctn)
490960	HY/WISE/10W/6000K	220V-240V	10W	6000K	880lm	>0.95	>80	2835	IP65	101x125x29mm	>30000	Die-casting Aluminum	1/30
490961	HY/WISE/20W/6000K	220V-240V	20W	6000K	1760lm	>0.95	>80	2835	IP65	129x151x30mm	>30000	Die-casting Aluminum	1/20
490962	HY/WISE/30W/6000K	220V-240V	30W	6000K	2640lm	>0.95	>80	2835	IP65	163x186x34mm	>30000	Die-casting Aluminum	1/12
490963	HY/WISE/50W/6000K	220V-240V	50W	6000K	4400lm	>0.95	>80	2835	IP65	193x258x37mm	>30000	Die-casting Aluminum	1/8

Outdoor Lighting

## Led Flood Light High Wattage

A++ A IP65 Ra>80 30000h CE

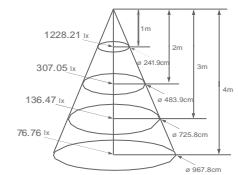
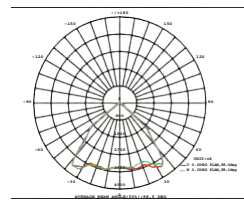
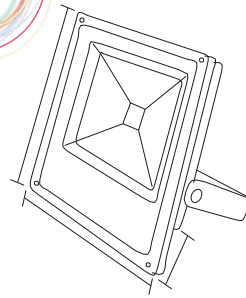

Code	Model no.	Input Voltage	Power (W)	Temperature (K)	Luminous Flux (lm)	Power factor	CRI	LED Type	IP	Product Size (L/W/H)	Average Life (hrs)	Material	Quantity (pcs/ctn)
490964	HY/WISE/100W/6000K	220V-240V	100W	6000K	8800lm	>0.95	>80	2835	IP65	306x316x71mm	>30000	Die-casting Aluminum	1/4
490965	HY/WISE/150W/6000K	220V-240V	150W	6000K	13200lm	>0.95	>80	2835	IP65	364x391x72mm	>30000	Die-casting Aluminum	1/4
490966	HY/WISE/200W/6000K	220V-240V	200W	6000K	17600lm	>0.95	>80	2835	IP65	429x471x70mm	>30000	Die-casting Aluminum	2

## Led Flood Light with Motion Sensor

A++ A IP65 Ra>80 30000h CE

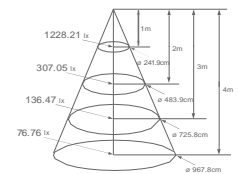
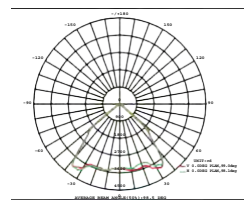
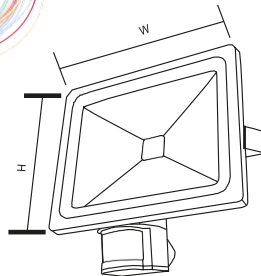

Code	Model no.	Voltage (V)	Power (W)	Color Temperature (K)	Luminous Flux (lm)	Power factor	CRI	LED Type	IP	Product Size (L/W/H)	Average Life (hrs)	Material	Quantity (pcs/ctn)
490967	HY/WISE/PIR/20W/6000K	220V-240V	20W	6000K	1760lm	>0.95	>80	2835	IP65	129x151x30mm	>30000	Die-casting Aluminum	1/20
490968	HY/WISE/PIR/30W/6000K	220V-240V	30W	6000K	2640lm	>0.95	>80	2835	IP65	163x186x34mm	>30000	Die-casting Aluminum	1/12
490969	HY/WISE/PIR/50W/6000K	220V-240V	50W	6000K	4400lm	>0.95	>80	2835	IP65	193x258x37mm	>30000	Die-casting Aluminum	1/8

# FLOOD LIGHT

Outdoor Lighting



TRIPOD Stand

Code	Model no.	Product Size (L/W/H)	Quantity (pcs/ctn)
490955	HY/TRIPOD/1.6M/Y	680x780x1600mm	12



## Led Flood Light

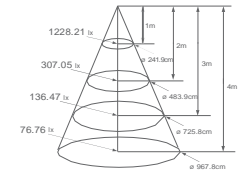
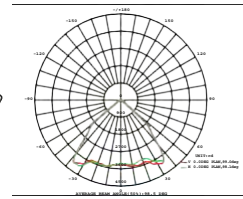
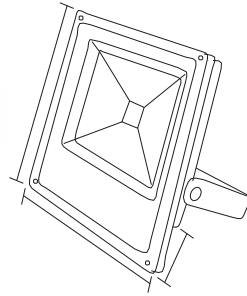

Code	Model no.	Voltage (V)	Power (W)	Temperature (K)	Luminous Flux (lm)	Power factor	CRI	LED Type	Product Size (L/W/H)	Average Life (hrs)	Material	Quantity (pcs/ctn)
490940	HY/FL01X/10W/6000K	220-240V	10W	6000K	800lm	>0.95	>70	2835	103x94x23mm	>30000	Die-casting Aluminum	1/90
490941	HY/FL02X/20W/6000K	220-240V	20W	6000K	1600lm	>0.95	>70	2835	134x108x24mm	>30000	Die-casting Aluminum	1/90
490942	HY/FL03X/30W/6000K	220-240V	30W	6000K	2400lm	>0.95	>70	2835	161x125x25mm	>30000	Die-casting Aluminum	1/60
490943	HY/FL04X/50W/6000K	220-240V	50W	6000K	4000lm	>0.95	>70	2835	210x173x33mm	>30000	Die-casting Aluminum	1/32

Outdoor Lighting

## Led Flood Light High Wattage

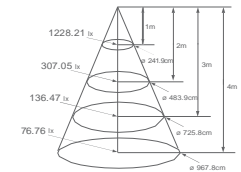
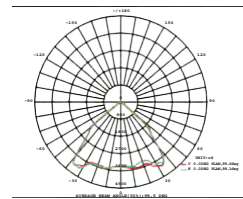
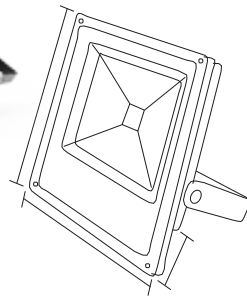

Code	Model no.	Voltage (V)	Power (W)	Temperature (K)	Luminous Flux (lm)	Power factor	CRI	LED Type	Product Size (L/W/H)	Average Life (hrs)	Material	Quantity (pcs/ctn)
490945	HY/FL10X/100W/6000K	220-240V	100W	6000K	8000lm	>0.95	>70	2835	327x250x40mm	>30000	Die-casting Aluminum	1/10
490946	HY/FL15X/150W/6000K	220-240V	150W	6000K	12000lm	>0.95	>70	2835	380x295x40mm	>30000	Die-casting Aluminum	1/10
490947	HY/FL20X/200W/6000K	220-240V	200W	6000K	16000lm	>0.95	>70	2835	418x334x41.5mm	>30000	Die-casting Aluminum	1/10

## Led Flood Light with Motion Sensor

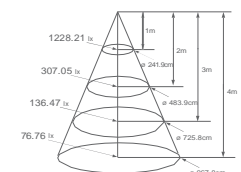
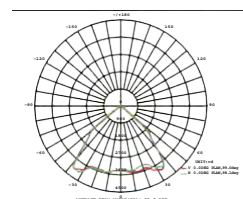
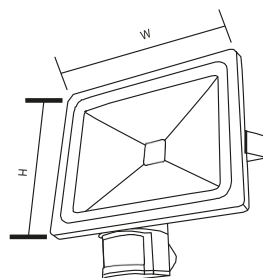

Code	Model no.	Voltage (V)	Power (W)	Temperature (K)	Luminous Flux (lm)	Power factor	CRI	LED Type	IP	Product Size (L/W/H)	Average Life (hrs)	Material	Quantity (pcs/ctn)
490948	HY/FL02IX/PIR/20W/6000K	220-240V	20W	6000K	1600lm	>0.95	>70	2835	IP65	134x108x24mm	>30000	Die-casting Aluminum	1/90
490949	HY/FL03IX/PIR/30W/6000K	220-240V	30W	6000K	2400lm	>0.95	>70	2835	IP65	161x125x25mm	>30000	Die-casting Aluminum	1/60

Outdoor Lighting



STREET  
LIGHT

## Led Street Light

A++ A IP65 50000h Ra>70 SMD LED CE

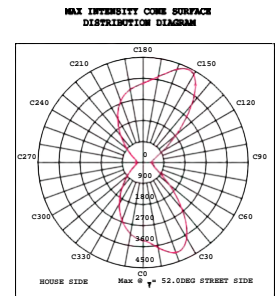
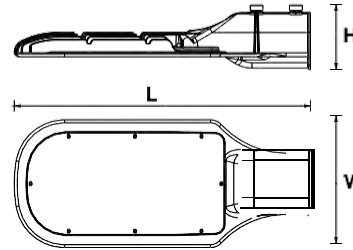

Outdoor Lighting

Code	Model no.	Voltage (V)	Power (W)	Temperature (K)	Luminous Flux (lm)	Power factor	CRI	IP	Product Size (L/W/H)	Average Life (hrs)	Material	Ø mm	Quantity (pcs/ctn)
490625	HY/SL30ST/30W/6000K	220-240V	30W	6000K	2700lm	>0.95	>70	IP65	302x130x66mm	50000	Die-casting Aluminum	Ø45	1/1
490626	HY/SL50ST/50W/6000K	220-240V	50W	6000K	4500lm	>0.95	>70	IP65	396x170x88mm	50000	Die-casting Aluminum	Ø60	1/1
490627	HY/SL100ST/100W/6000K	220-240V	100W	6000K	9000lm	>0.95	>70	IP65	460x220x88mm	50000	Die-casting Aluminum	Ø60	1/1
490628	HY/SL120ST/120W/6000K	220-240V	120W	6000K	12000lm	>0.95	>70	IP65	460x220x88mm	50000	Die-casting Aluminum	Ø60	1/1

## Professional Led Street Light

A++ A IP66 30000h Ra>80 SMD LED CE

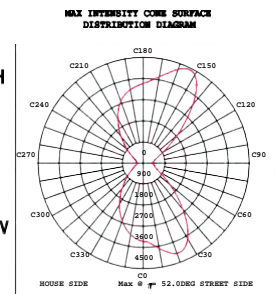
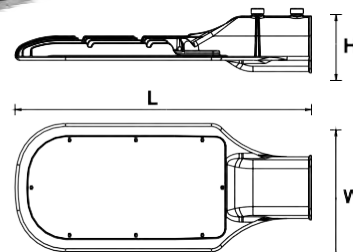
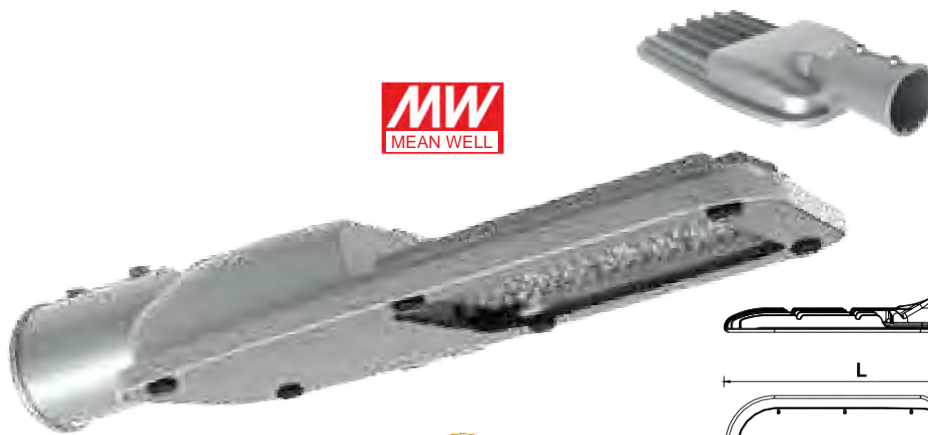

Code	Model no.	Voltage (V)	Power (W)	Temperature (K)	Luminous Flux (lm)	Power factor	CRI	IK	IP	Product Size (L/W/H)	Average Life (hrs)	Material	Ø mm	Quantity (pcs/ctn)
490980	HY/YZDL761M/30W/6000K	100-227V	30W	6000K	3600lm	>0.95	>70	IK08	IP66	425x177x92	50000	Die-casting Aluminum	Ø60	1/1
490981	HY/YZDL761M/50W/6000K	100-227V	50W	6000K	6000lm	>0.95	>70	IK08	IP66	425x177x92	50000	Die-casting Aluminum	Ø60	1/1
490982	HY/YZDL761B/100W/6000K	100-227V	100W	6000K	12000lm	>0.95	>70	IK08	IP66	541x258x92	50000	Die-casting Aluminum	Ø60	1/1
490983	HY/YZDL761B/120W/6000K	100-227V	120W	6000K	14400lm	>0.95	>70	IK08	IP66	541x258x92	50000	Die-casting Aluminum	Ø60	1/1

# FE HIGH BAY

Outdoor Lighting



## Led High Bay

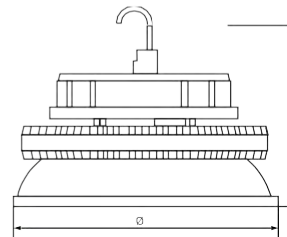

LUMINOUS INTENSITY DISTRIBUTION DIAGRAM

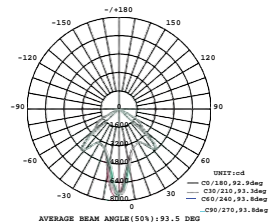

Code	Model no.	Input Voltage (V)	Nominal Power (W)	Color Temperature (K)	Reflector	Luminous Flux (lm)	IP	Product Size (L/W/H)	Average Life (hrs)	Quantity (pcs/ctn)
490698	HY/LED/HB/120W/5000K	220-240V	120W	5000K	symmetric	12700 lm	IP65	Ø368x305	50000	1/1
490699	HY/LED/HB/180W/5000K	220-240V	180W	5000K	symmetric	18100 lm	IP65	Ø425x322	50000	1/1

## Led High Bay Profi Line

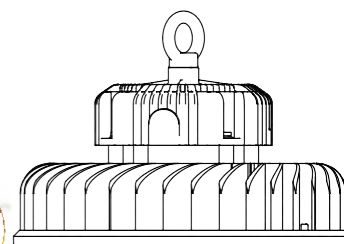
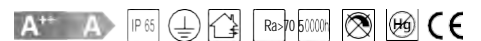

LUMINOUS INTENSITY DISTRIBUTION DIAGRAM

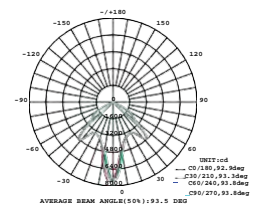

Code	Model no.	Input Voltage (V)	Nominal Power (W)	Color Temperature (K)	Reflector	Luminous Flux (lm)	IP	Product Size (L/W/H)	Average Life (hrs)	Quantity (pcs/ctn)
490698-1	HY/LED/HB/150W/6500K	220-240V	150W	6500K	No	16500	IP65	185x185x200	50000	1/1
490690-1	HY/LED/HB/200W/6500K	220-240V	200W	6500K	No	22000	IP65	240x240x200	50000	1/1

Outdoor Lighting



**GARDEN  
FIXTURES**

## Wall lamp, INOX

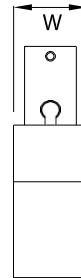
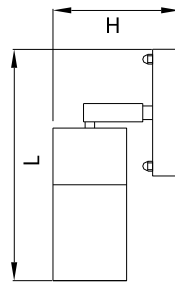

L:188 W:60 H:103

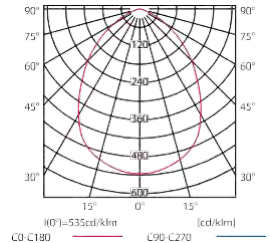
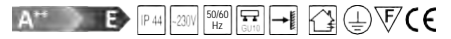

Code	Model no.	Input Voltage (V)	Nominal Power (W)	Base	Color	IP	Quantity (pcs/ctn)
490040	HY169A-ST	220-240V	35-50W	GU10	Inox	IP44	1/12

## Wall lamp, INOX

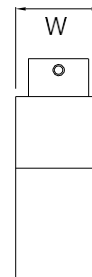
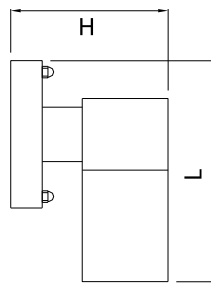

L:155 W:60 H:110

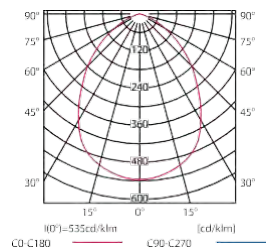
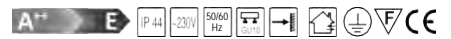

Code	Model no.	Input Voltage (V)	Nominal Power (W)	Base	Color	IP	Quantity (pcs/ctn)
490041	HY169B-ST	220-240V	35-50W	GU10	Inox	IP44	1/12

## Wall lamp, INOX, UP - DOWN

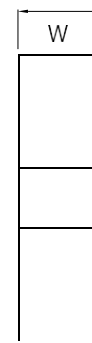
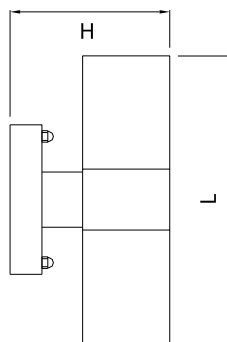



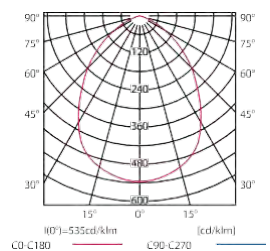
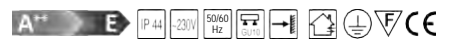

L:200 W:60 H:110



Code	Model no.	Input Voltage (V)	Nominal Power (W)	Base	Color	IP	Quantity (pcs/ctn)
490042	HY169C-ST	220-240V	35-50W	2xGU10	Inox	IP44	1/8



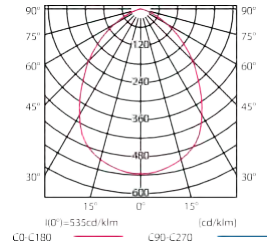

## Wall lamp

A+ → E IP 44 ~230V 50/60 Hz     



Code	Model no.	Input Voltage (V)	Nominal Power (W)	Base	Color	IP	Quantity (pcs/ctn)
490080	HY/146 A+L	220-240V	35-50W	GU10	Black	IP44	1/24
490080-1	HY/146 A+L/W	220-240V	35-50W	GU10	White	IP44	1/24

## Wall lamp

A+ → E IP 44 ~230V 50/60 Hz     

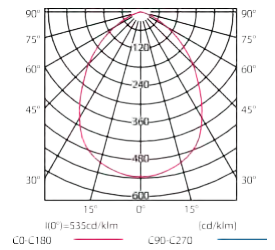

Code	Model no.	Input Voltage (V)	Nominal Power (W)	Base	Color	IP	Quantity (pcs/ctn)
490081	HY/146 B+L	220-240V	35-50W	GU10	Black	IP44	1/24
490081-1	HY/146 B+L/W	220-240V	35-50W	GU10	White	IP44	1/24

## Wall lamp, UP - DOWN

A+ → E IP 44 ~230V 50/60 Hz     

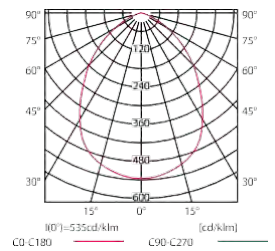

Code	Model no.	Input Voltage (V)	Nominal Power (W)	Base	Color	IP	Quantity (pcs/ctn)
490082	HY/146 C+L	220-240V	35-50W	2xGU10	Black	IP44	1/16
490082-2	HY/146 C+L/W	220-240V	35-50W	2xGU10	White	IP44	1/16



## Wall lamp

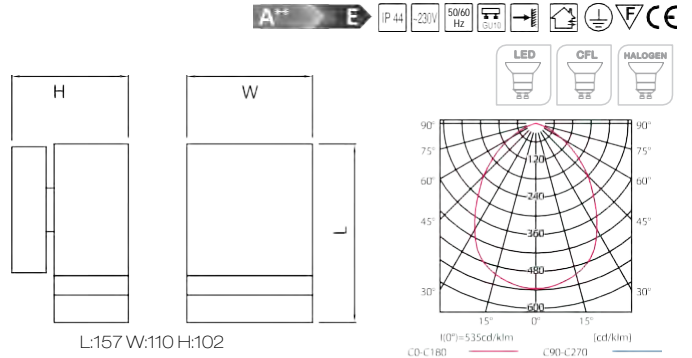

Code	Model no.	Input Voltage (V)	Nominal Power (W)	Base	Color	IP	Quantity (pcs/ctn)
490043	HY/257	220-240V	35-50W	GU10	Silver Grey	IP44	1/24

## Wall lamp, Up - Down

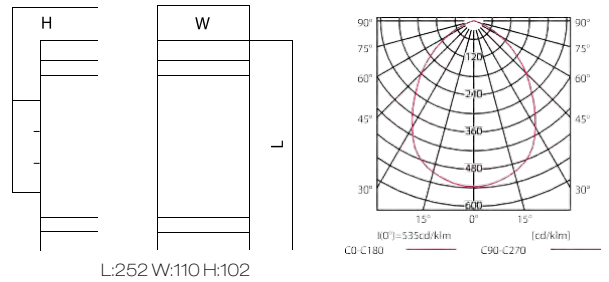

Code	Model no.	Input Voltage (V)	Nominal Power (W)	Base	Color	IP	Quantity (pcs/ctn)
490044	HY/257-2	220-240V	35-50W	2xGU10	Silver Grey	IP44	1/12

## Wall lamp

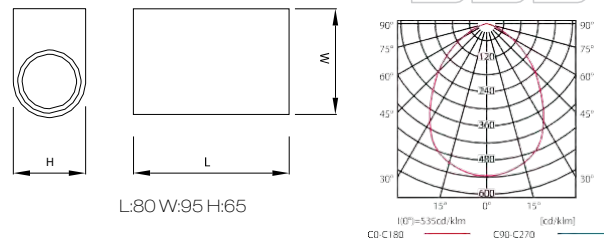

Code	Model no.	Input Voltage (V)	Nominal Power (W)	Base	Color	IP	Quantity (pcs/ctn)
490045	HY/247	220-240V	35-50W	GU10	Grey	IP44	1/24
490045-1	HY/247/W	220-240V	35-50W	GU10	White	IP44	1/24

## Wall Lamp, Up - Down

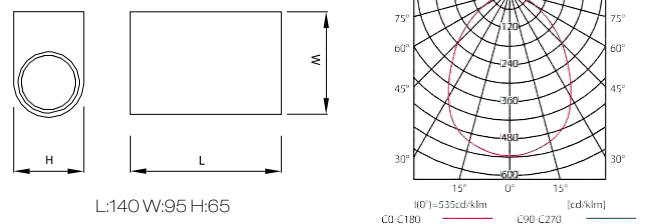

Code	Model no.	Input Voltage (V)	Nominal Power (W)	Base	Color	IP	Quantity (pcs/ctn)
490046	HY/247	220-240V	35-50W	GU10	Grey	IP44	1/24

490046-1

HY/247/W

220-240V

35-50W

GU10

White

IP44

1/24

## Wall lamp, UP - DOWN

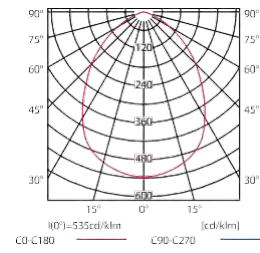

Code	Model no.	Input Voltage (V)	Nominal Power (W)	Base	Color	IP	Quantity (pcs/ctn)
490083	HY/297 -2	220-240V	LED 2x1,6W	/	Black	IP44	1/24

## Wall lamp

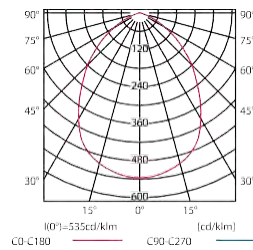

Code	Model no.	Input Voltage (V)	Nominal Power (W)	Base	Color	IP	Quantity (pcs/ctn)
490084	HY/297	220-240V	LED 1x1,6W	/	Black	IP44	1/24

## Wall lamp

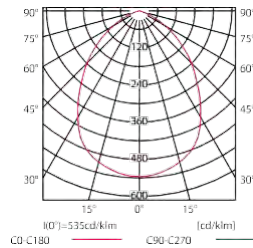
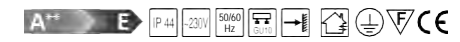

Code	Model no.	Input Voltage (V)	Nominal Power (W)	Base	Color	IP	Quantity (pcs/ctn)
490086	HY/247 F	220-240V	35W	GU10	Black	IP44	1/24

## Wall lamp, UP - DOWN

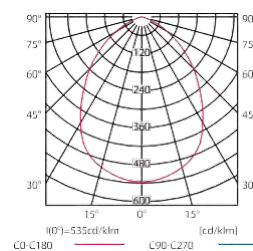
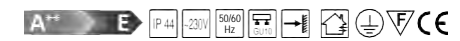

Code	Model no.	Input Voltage (V)	Nominal Power (W)	Base	Color	IP	Quantity (pcs/ctn)
490087	HY/247 F-2	220-240V	35W	2xGU10	Black	IP44	1/16

## Wall lamp

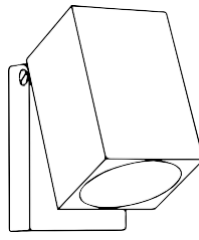

L:92 W:65 H:100

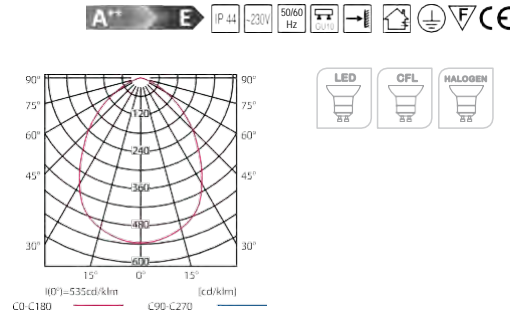

Code	Model no.	Input Voltage (V)	Nominal Power (W)	Base	Color	IP	Quantity (pcs/ctn)
490088	HY/347	220-240V	35W	GU10	Aluminium	IP44	1/24

## Wall lamp with sensor

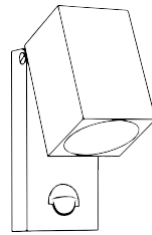

L:95 W:65 H:160

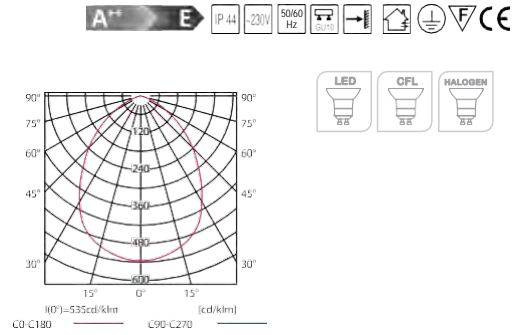

Code	Model no.	Input Voltage (V)	Nominal Power (W)	Base	Color	IP	Quantity (pcs/ctn)
490089	HY/347+SEN	220-240V	2x35W	2xGU10	Aluminium	IP44	1/24

## Floor lamp 0,5 m

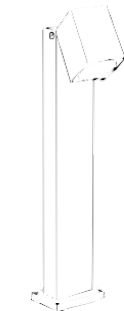

L:110 W:90 H:500

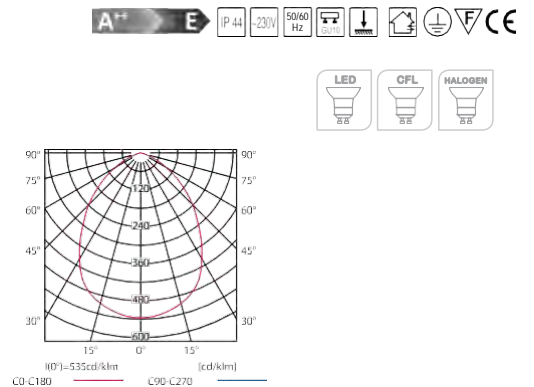

Code	Model no.	Input Voltage (V)	Nominal Power (W)	Base	Color	IP	Quantity (pcs/ctn)
490090	HY/347PSH0.5	220-240V	35W	GU10	Aluminium	IP44	1/6

## Floor lamp 0,8 m



L:110 W:90 H:800

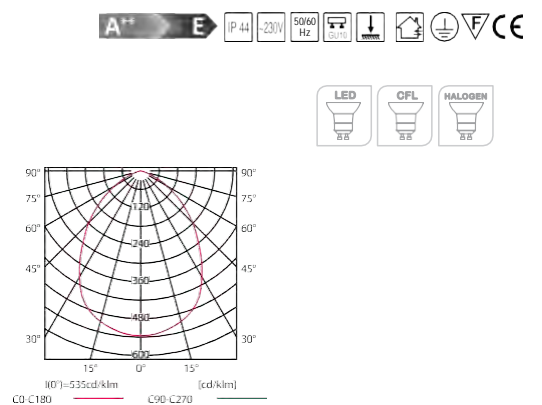

Code	Model no.	Input Voltage (V)	Nominal Power (W)	Base	Color	IP	Quantity (pcs/ctn)
490091	HY/347PSH0.8	220-240V	35W	GU10	Aluminium	IP44	1/6

## LED Wall lamp

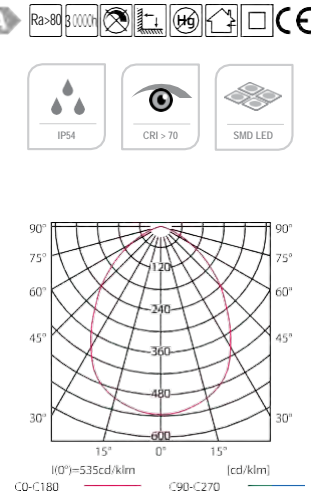
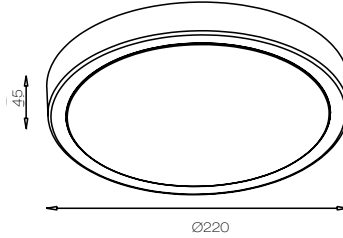

Code	Model no.	Voltage (V)	Power (W)	Color Temp. (K)	Color	IP	Lumen (Lm)	CRI (Ra)	Beam angle (°)	Life (hrs)	Product Size (L/W/H)	Quantity (pcs/ctn)
490031	HY/CL22HYCA/	220-240V	15W	4000K	Black	IP54	1050	>80	120	30000	Ø220x45mm	1/20

## LED Wall lamp

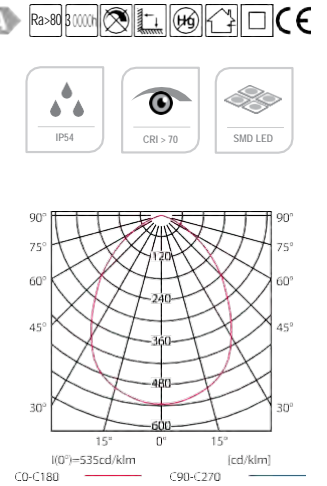
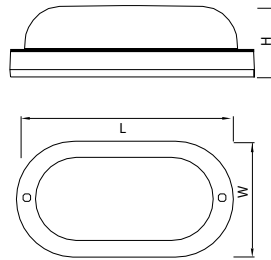

Code	Model no.	Input Voltage (V)	Nominal Power (W)	Color Temp. (K)	Color	IP	Lumen (Lm)	CRI (Ra)	Beam angle (°)	Life (hrs)	Product Size (L/W/H)	Quantity (pcs/ctn)
490032	HY/CL22HYOA/15W/4000K/B	220-240V	15W	4000K	Black	IP54	1050	>80	120	30000	220x110x45mm	1/20

## Bulkhead Fixtures 100w

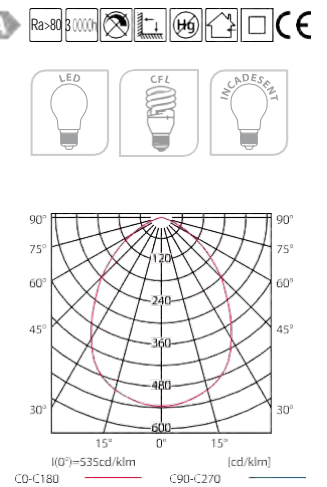
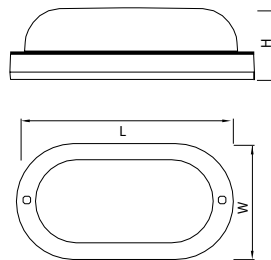

Code	Model no.	Input Voltage (V)	Nominal Power (W)	IP	Dimensions (mm)	Material	Quantity (pcs/ctn)
333995	HY/BH/7040T/60W	220-240VAC	60W	44	165x100x110mm	Plastic/Glass/Wire	1/12

## LED Wall lamp

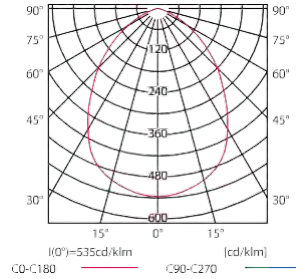
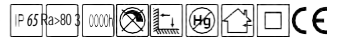
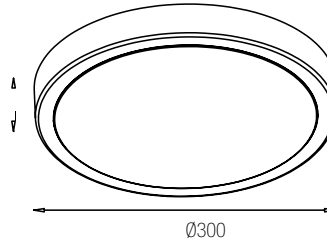

Code	Model no.	Input Voltage (V)	Nominal Power (W)	Color Temp. (K)	Color	IP	Lumen (Lm)	CRI (Ra)	Beam angle (°)	Life (hrs)	Product Size (L/W/H)	Quantity (pcs/ctn)
490049	HY/FH19901/A	220-240V	20W	4000K	Anthracite	IP65	1275lm	>80	120	30000	Ø300X66mm	1/8

## LED Wall lamp

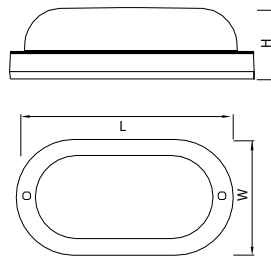

L:197 W:112 H:74.5

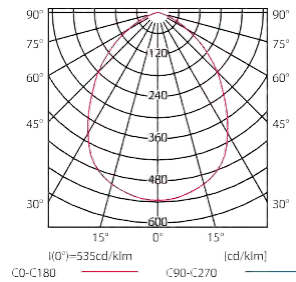

Code	Model no.	Input voltage (V)	Nominal Power (W)	Color Temp. (K)	Color	IP	Lumen (Lm)	CHI (Ra)	Beam angle (°)	Life (hrs)	Quantity (pcs/ctn)
490048	HY/17901/A	220-240V	10W	6500K	Anthracite	IP65	800 lm	>80	120	30000	1/36

## Bulkhead Fixtures 100w

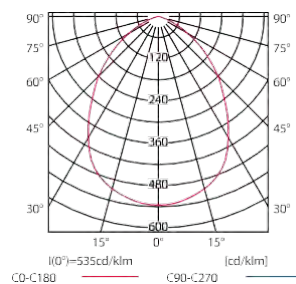
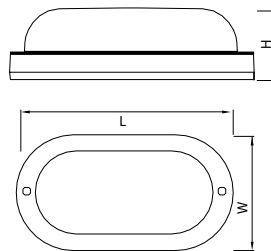

Code	Model no.	Input Voltage (V)	Nominal Power (W)	IP	Dimensions LxWxH (mm)	Material	Quantity (pcs/ctn)
333996	HY/BH/7063NB/100W	220-240VAC	100W	54	190x110x124mm	Bakelite/Glass/Wire	1/12

## LED Round Recessed Fixture

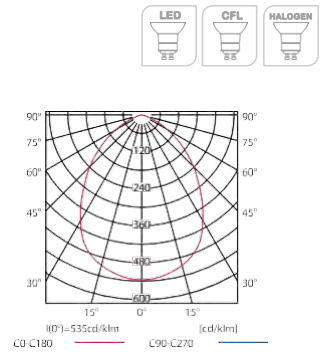
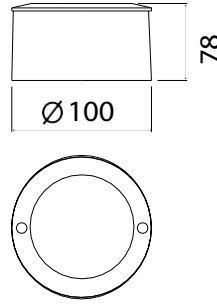

Code	Model no.	Input voltage (V)	Nomial Power (W)	Base	Color	IP	Lumen (Lm)	CRI (Ra)	Beam angle (°)	Life (hrs)	Product Size (L/W/H)	Quantity (pcs/ctn)
490033-1	HY/HC04101/	220-240V	35W	GU10	Nickel	IP67	130 lm	>80	120	30000	f100x78	1/8

Outdoor Lighting

## LED Round Recessed Fixture

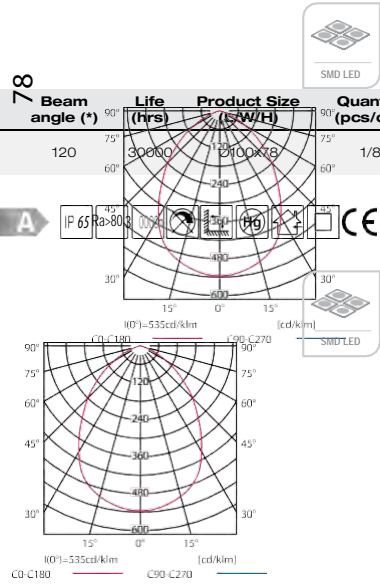
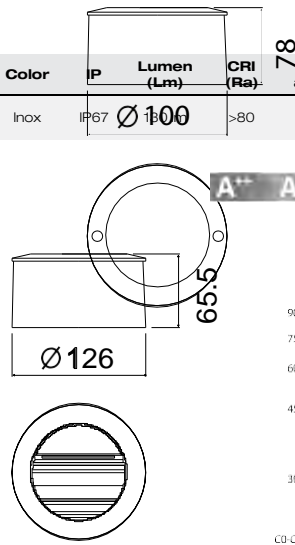
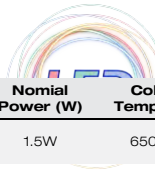
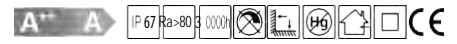

Code	Model no.	Input voltage (V)	Nomial Power (W)	Color Temp. (K)	Color	IP	Lumen (Lm)	CRI (Ra)	Beam angle (°)	Life (hrs)	Product Size (L/W/H)	Quantity (pcs/ctn)
490033	HY/801	220-240V	1.5W	6500K	Inox	IP67	100	>80	120	30000	f100x78	1/8

## LED Round Recessed Fixture

Code	Model no.	Input voltage (V)	Nomial Power (W)	Color Temp. (K)	Color	IP	Lumen (Lm)	CRI (Ra)	Beam angle (°)	Life (hrs)	Product Size (L/W/H)	Quantity (pcs/ctn)
490035	HY/02501	220-240V	1.2W	6500K	Grey	IP65	100 lm	>80	120	30000	f120x66	1/20

## LED Square Recessed fixture

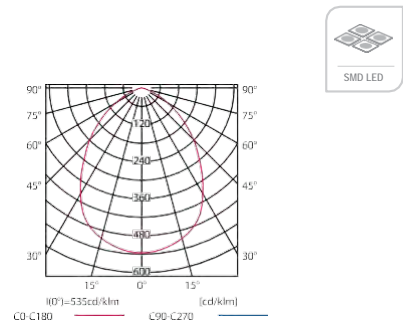
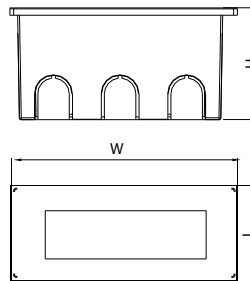
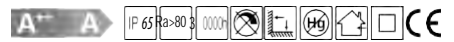

Code	Model no.	Input voltage (V)	Nomial Power (W)	Color Temp. (K)	Color	IP	Lumen (Lm)	CRI (Ra)	Beam angle (°)	Life (hrs)	Product Size (L/W/H)	Quantity (pcs/ctn)
490038	HY/07501	220-240V	1.5W	6500K	Inox	IP65	130 lm	>80	120	30000	123x53x61	1/50



## LED Square Recessed fixture

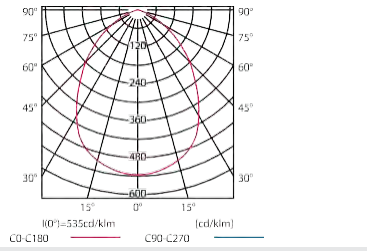
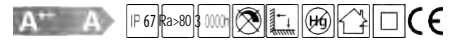
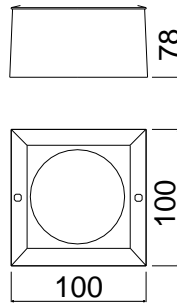

Code	Model no.	voltage (V)	Nomial Power (W)	Base	Color	IP	Lumen (Lm)	CRI (Ra)	Beam angle (°)	Life (hrs)	Product Size (L/W/H)	Quantity (pcs/ctn)
490034-1	HY/HC04001/GU10/67/NM	220-240V	35W	GU10	Nickel Mat	IP67	130 lm	>80	120	30000	100x100x78	1/8

## LED Square Recessed fixture

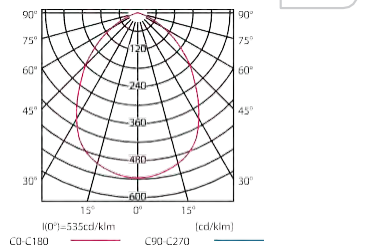
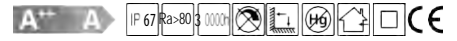
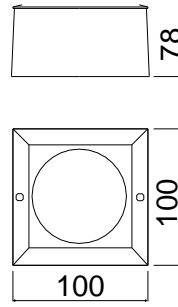

Code	Model no.	Input voltage (V)	Nomial Power (W)	Color Temp. (K)	Color	IP	Lumen (Lm)	CRI (Ra)	Beam angle (°)	Life (hrs)	Product Size (L/W/H)	Quantity (pcs/ctn)
490034	HY/801A	220-240V	1.5W	6500K	Inox	IP67	130 lm	>80	120	30000	100x100x78	1/8

## LED Square Recessed fixture

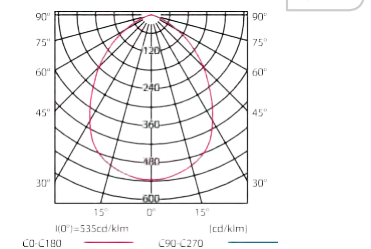
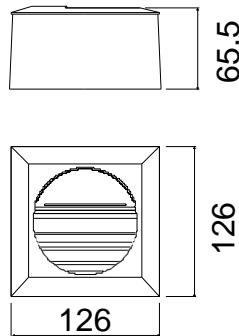

Code	Model no.	Input voltage (V)	Nomial Power (W)	Color Temp. (K)	Color	IP	Lumen (Lm)	CRI (Ra)	Beam angle (°)	Life (hrs)	Product Size (L/W/H)	Quantity (pcs/ctn)
490036	HY/02601	220-240V	1.2W	6500K	Grey	IP65	100 lm	>80	120	30000	120x120x66	1/20

## LED Square Recessed fixture

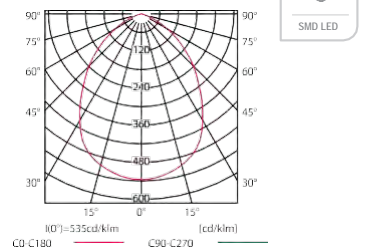
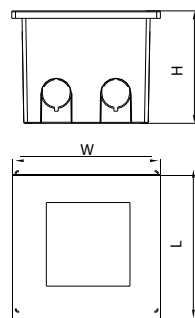

Code	Model no.	Input voltage (V)	Nomial Power (W)	Color Temp. (K)	Color	IP	Lumen (Lm)	CRI (Ra)	Beam angle (°)	Life (hrs)	Product Size (L/W/H)	Quantity (pcs/ctn)
490037	HY/07401	220-240V	1.5W	6500K	Inox	IP65	130 lm	>80	120	30000	80x80x61	1/50



## LED Round Recessed Fixture

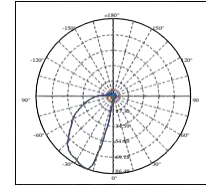
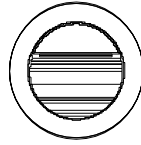
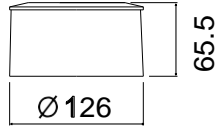

Code	Model no.	voltage (V)	Power (W)	Color Temp. (K)	Color	IP	Lumen (Lm)	CRI (Ra)	Beam angle (°)	Life (hrs)	Product Size (L/W/H)	Quantity (pcs/ctn)
490035-1	HY/FG02501/ 1.5W/4000KA	220-240V	1.5W	4000K	Antracit	IP65	100 lm	>80	120	30000	120x66	1/20

## LED Square Recessed fixture

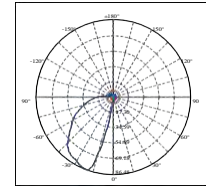
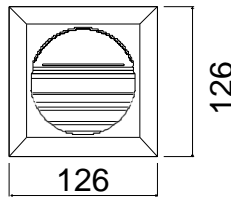
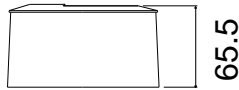

Code	Model no.	voltage (V)	Power (W)	Color Temp. (K)	Color	IP	Lumen (Lm)	CRI (Ra)	Beam angle (°)	Life (hrs)	Product Size (L/W/H)	Quantity (pcs/ctn)
490036-1	HY/FG02601/ 1.5W/4000KA	220-240V	1.5W	4000K	Antracit	IP65	100 lm	>80	120	30000	120x66	1/20

## LED Round Surface Fixture

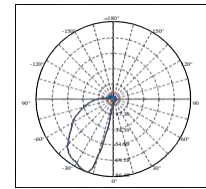
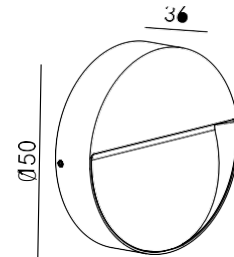

Code	Model no.	voltage (V)	Power (W)	Color Temp. (K)	Color	IP	Lumen (Lm)	CRI (Ra)	Beam angle (°)	Life (hrs)	Product Size (L/W/H)	Quantity (pcs/ctn)
490035-2	HY/FH21901/A	220-240V	6W	4000K	Antracit	IP54	140 lm	>80	120	30000	<150x36mm	1/18

## LED Square Surface Fixture

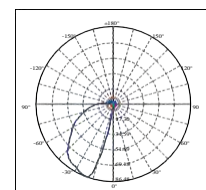
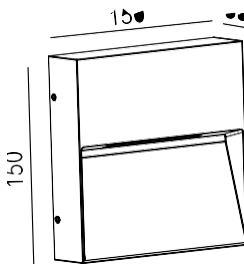

Code	Model no.	voltage (V)	Power (W)	Color Temp. (K)	Color	IP	Lumen (Lm)	CRI (Ra)	Beam angle (°)	Life (hrs)	Product Size (L/W/H)	Quantity (pcs/ctn)
490036-2	HY/FH22001/A	220-240V	6W	4000K	Antracit	IP54	140 lm	>80	120	30000	150x150x36mm	1/18

## Led Wall lamp

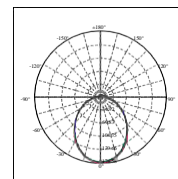
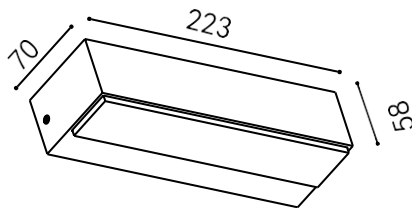

Code	Model no.	Voltage (V)	Power (W)	Color Temp. (K)	Color	IP	Lumen (Lm)	CRI (Ra)	Beam angle (°)	Life (hrs)	Product Size (L/W/H)	Quantity (pcs/ctn)
490077	HY/FH22201/8W/ IP54/4000K/A	220-240V	8W	4000K	Antracit	IP54	480lm	>80	120	30000	223x72x38mm	1/10

## Led Wall lamp

Adjustable 0-100°

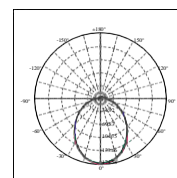
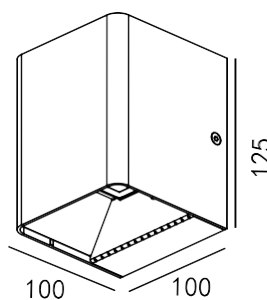

Code	Model no.	Voltage (V)	Power (W)	Color Temp. (K)	Color	IP	Lumen (Lm)	CRI (Ra)	Beam angle (°)	Life (hrs)	Product Size (L/W/H)	Quantity (pcs/ctn)
490077-1	HY/BH20001/ 2x6W/4000K/A	220-240V	2x6W	4000K	Antracit	IP54	2x350lm	>80	120	30000	100x100x125mm	1/18

## Led Wall lamp

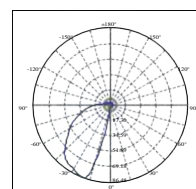
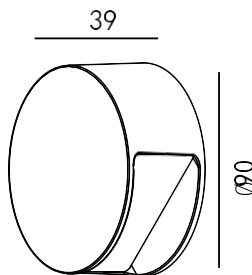

Code	Model no.	Voltage (V)	Power (W)	Color Temp. (K)	Color	IP	Lumen (Lm)	CRI (Ra)	Beam angle (°)	Life (hrs)	Product Size (L/W/H)	Quantity (pcs/ctn)
490078	HY/FH07001/4W/ IP54/4000K/A	220-240V	4W	4000K	Antracit	IP54	140lm	>80	120	30000	Ø90x39mm	1/50

## Led Wall lamp

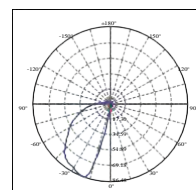
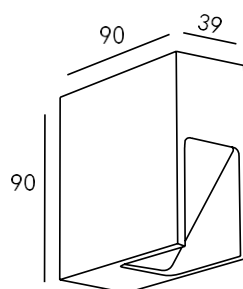
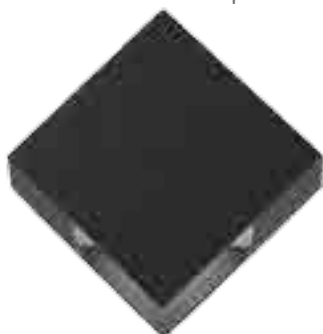

Code	Model no.	Voltage (V)	Power (W)	Color Temp. (K)	Color	IP	Lumen (Lm)	CRI (Ra)	Beam angle (°)	Life (hrs)	Product Size (L/W/H)	Quantity (pcs/ctn)
490079	HY/FH07101/4W/ IP54/4000K/A	220-240V	4W	4000K	Antracit	IP54	140lm	>80	120	30000	90x90x39mm	1/50

## Wall lamp

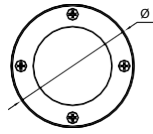
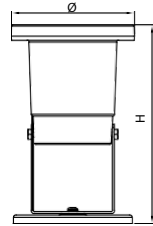

L:188 W:60 H:103

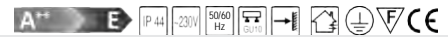
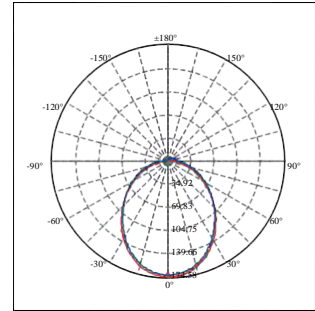

Code	Model no.	Input Voltage (V)	Nominal Power (W)	Base	Color	IP	Quantity (pcs/ctn)
490047	HY/9017	220-240V	35-50W	GU10	Black	IP44	1/12

## Wall lamp

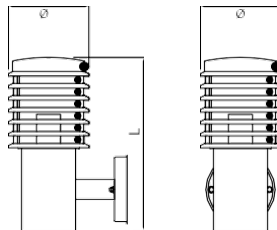

L:330 Ø:150

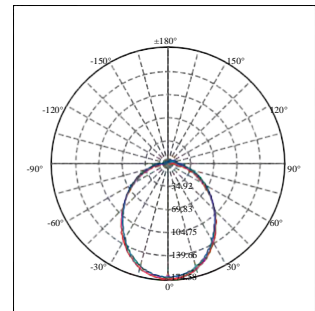
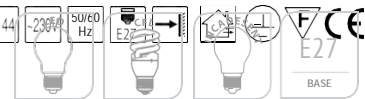
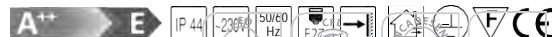

Code	Model no.	Input Voltage (V)	Nominal Power (W)	Base	Color	IP	Quantity (pcs/ctn)
490098	HY/901CWJ	220-240V	100W Inca. Bulb	1xE27	Stainless steel	IP44	1/6

## Floor lamp 0,5 m

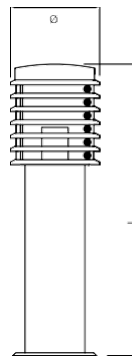

L:500 Ø:150

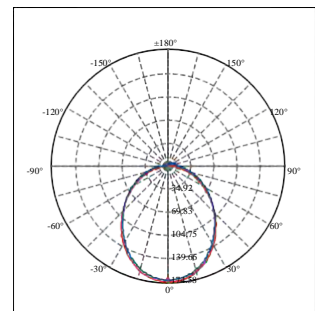
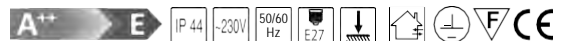

Code	Model no.	Input Voltage (V)	Nominal Power (W)	Base	Color	IP	Quantity (pcs/ctn)
490099	HY/901CPSH0.5	220-240V	100W Inca. Bulb	1xE27	Stainless steel	IP44	1/6

## Wall lamp

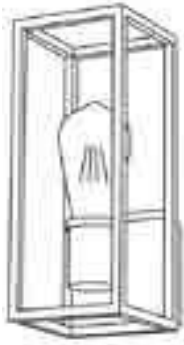

L: 140 W: 110 H: 270

A++ E IP 44 ~230V 50/60 Hz

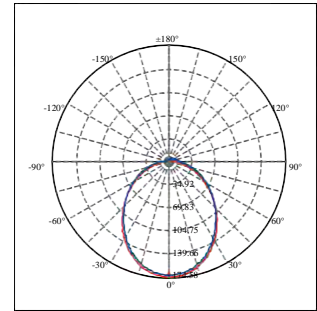

Code	Model no.	Input Voltage (V)	Nominal Power (W)	Base	Color	IP	Quantity (pcs/ctn)
490075	HY/662/B	220-240V	60W Inca. Bulb	1xE27	Black	IP44	1/6

## Wall lamp



L: 110 W: 105 H: 220

A++ E IP 44 ~230V 50/60 Hz

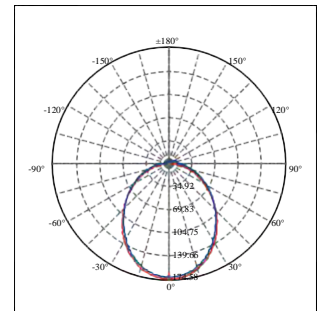

Code	Model no.	Input Voltage (V)	Nominal Power (W)	Base	Color	IP	Quantity (pcs/ctn)
490076	HY/1830-2/W	220-240V	35-50W	2xGU10	White	IP44	1/12

## Wall lamp



L: 350 W: 257 H: 295

A++ E IP 44 ~230V 50/60 Hz E27

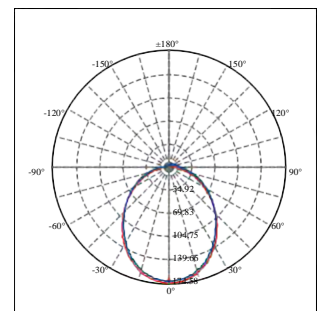

Code	Model no.	Input Voltage (V)	Nominal Power (W)	Base	Color	IP	Quantity (pcs/ctn)
490093	HY/958AWU-E27	220-240V	60W Inca. Bulb	1xE27	Black	IP44	1/4

## Wall lamp up

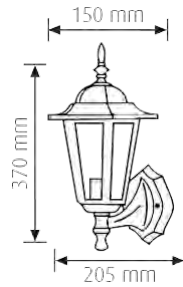

A+ E IP 44 ~230V 50/60 Hz E27

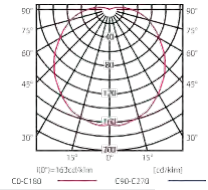

Code	Model no.	Color	Quantity (pcs/ctn)
490060	HY/GF/2004A/UP	matt black	1/10
490060-1	HY/GF/2004A/UP	white	1/10

## Wall lamp down

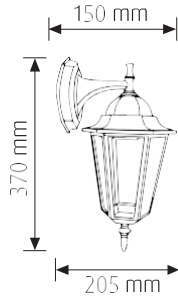

A+ E IP 44 ~230V 50/60 Hz E27

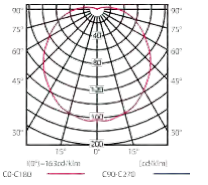

Code	Model no.	Color	Quantity (pcs/ctn)
490061	HY/GF/2004A/DN	matt black	1/10
490061-1	HY/GF/2004A/DN	white	1/10

## Hanging lamp

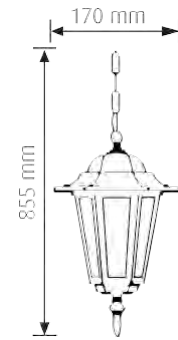

A+ E IP 44 ~230V 50/60 Hz E27

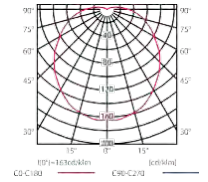

Code	Model no.	Color	Quantity (pcs/ctn)
490062	HY/GF/2004H	matt black	1/10
490062-1	HY/GF/2004H	white	1/10

## Standing lamp



A+ E IP 44 ~230V 50/60 Hz E27

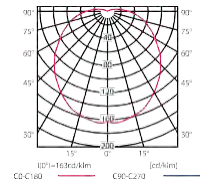

Code	Model no.	Color	Quantity (pcs/ctn)
490063	HY/GF/2004S1	matt black	1/10
490063-1	HY/GF/2004S1	white	1/10

## Floor lamp

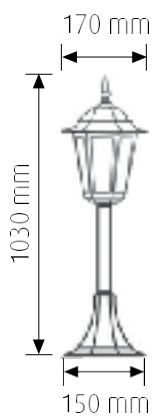

A+ E IP 44 ~230V 50/60 Hz E27

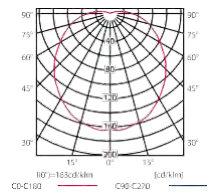

Code	Model no.	Color	Quantity (pcs/ctn)
490064-1	HY/GL/F180/60W/E27	matt black	1/1
490064	HY/GF/5004S1-60	matt black	1/10

## Wall lamp

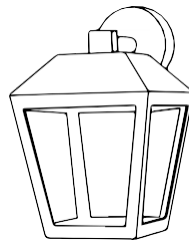

L:180 W:150 H:245

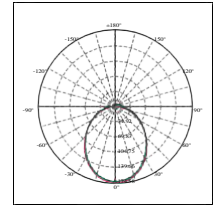
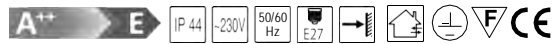

Code	Model no.	Input Voltage (V)	Nominal Power (W)	Base	Color	IP	Quantity (pcs/ctn)
490094	HY/437DN E27	220-240V	60W Inca. Bulb	1xE27	Black	IP44	1/6

## Floor lamp 0,5 m



L:150 W:150 H:500

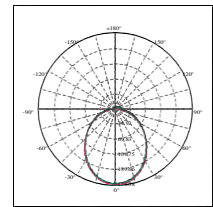
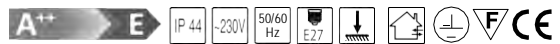

Code	Model no.	Input Voltage (V)	Nominal Power (W)	Base	Color	IP	Quantity (pcs/ctn)
490095	HY/437PCH0.5 E27	220-240V	60W Inca. Bulb	1xE27	Black	IP44	1/6

## Floor lamp 0,8 m



L:150 W:150 H:800

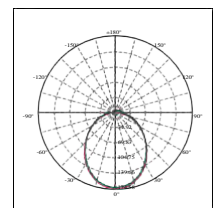
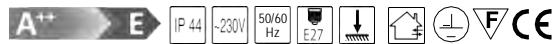

Code	Model no.	Input Voltage (V)	Nominal Power (W)	Base	Color	IP	Quantity (pcs/ctn)
490096	HY/437 PSE0.8 E27	220-240V	60W Inca. Bulb	1xE27	Black	IP44	1/6

## Hanging lamp



L:150 W:150 H:735

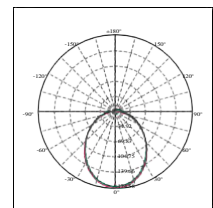
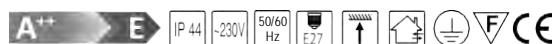

Code	Model no.	Input Voltage (V)	Nominal Power (W)	Base	Color	IP	Quantity (pcs/ctn)
490097	HY/437 HG E27	220-240V	60W Inca. Bulb	1xE27	Black	IP44	1/6

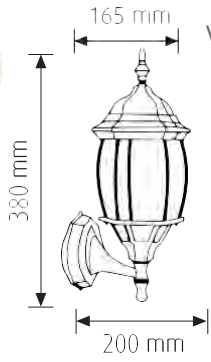

## Wall Lamp Up

A+ E IP44 ~230V 50/60 Hz E27



Code	Model no.	Color	Quantity (pcs/ctn)
490065	HY/GF/2005A/UP	matt black	1/10

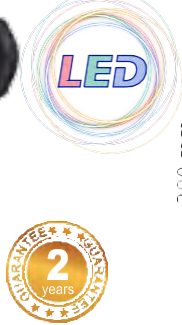
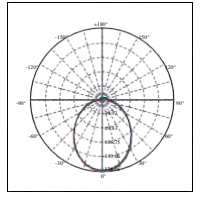

## Wall lamp Down

A+ E IP44 ~230V 50/60 Hz E27



Code	Model no.	Color	Quantity (pcs/ctn)
490066	HY/GF/2005A/DN	matt black	1/10

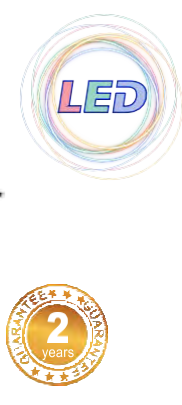
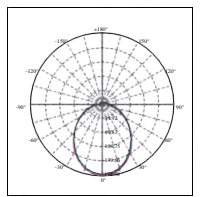

## Hanging Lamp

A+ E IP44 ~230V 50/60 Hz E27

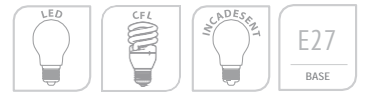

Code	Model no.	Color	Quantity (pcs/ctn)
490067	HY/GF/2005H	matt black	1/10

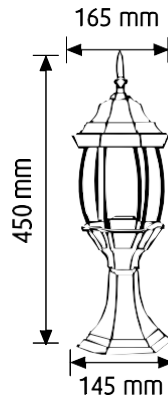
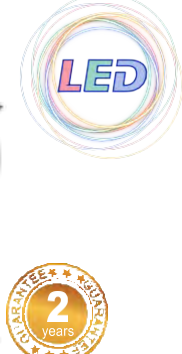
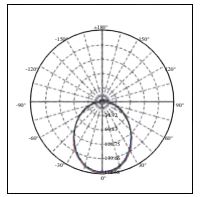

## Standing lamp

A+ E IP44 ~230V 50/60 Hz E27

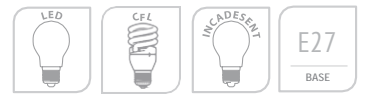

Code	Model no.	Color	Quantity (pcs/ctn)
490068	HY/GF/2005S1	matt black	1/10

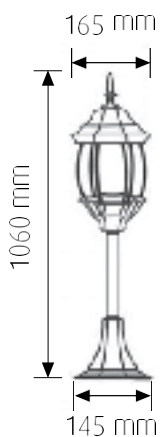
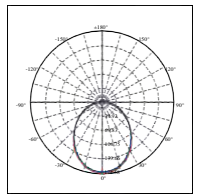

## Floor lamp

A+ E IP44 ~230V 50/60 Hz E27

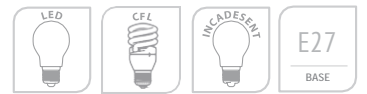

Code	Model no.	Color	Quantity (pcs/ctn)
490069	HY/GF/5005S1-60	matt black	1/10

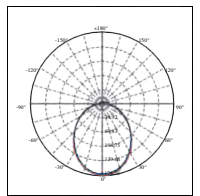

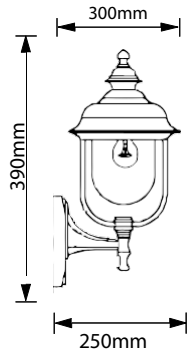

## Wall Lamp Up

A+ → E IP 44 -230V 50/60 Hz E27



Code	Model no.	Color	Quantity (pcs/ctn)
490070	HY/G F/2038B/UP	matt black gold cover	1/6

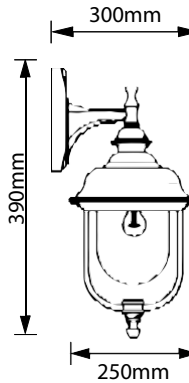
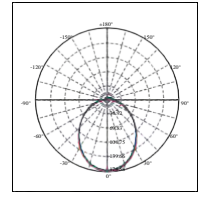

## Wall Lamp Down

A+ → E IP 44 -230V 50/60 Hz E27



Code	Model no.	Color	Quantity (pcs/ctn)
490071	HY/GF/2038B/DN	matt black gold cover	1/6

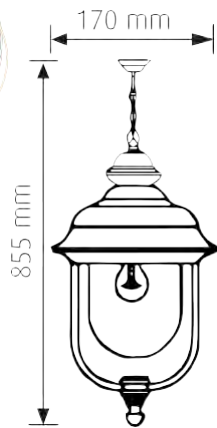
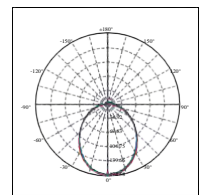

## Hanging Lamp

A+ → E IP 44 -230V 50/60 Hz E27



Code	Model no.	Color	Quantity (pcs/ctn)
490072	HY/GF/2038H	matt black gold cover	1/6

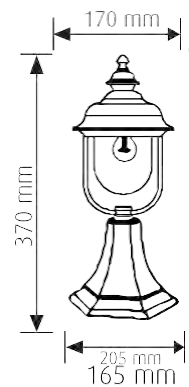
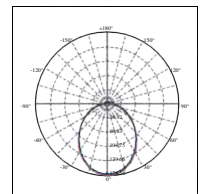

## Standing lamp

A+ → E IP 44 -230V 50/60 Hz E27



Code	Model no.	Color	Quantity (pcs/ctn)
490073	HY/GF/2038S1	matt black gold cover	1/6

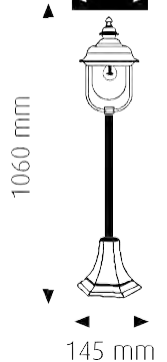
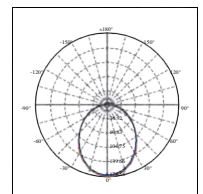

## Floor lamp

A+ → E IP 44 -230V 50/60 Hz E27



Code	Model no.	Color	Quantity (pcs/ctn)
490074	HY/GF/6038P	matt black gold cover	1/8

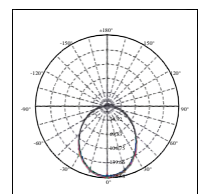



# FLIGHT BULBS



## Led Brilliant Bulbs A60

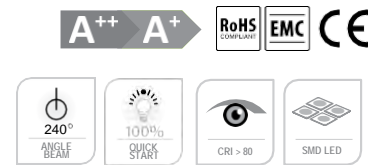

Code	Model no.	Voltage (V)	Power (W)	Temp. (K)	Lumen (Lm)	CRI (Ra)	Life (hrs)	Angle (°)	Base	Dimm. (mm)	Eq.claim	Qty (pcs/ctn)
490820	HY/LED/15W/E27/3000K	220-240V	15W	3000K	1500lm	>80	25000	240°	E27	Ø60x108	120W	1/10/50
490820-1	HY/LED/15W/E27/4000K	220-240V	15W	4000K	1500lm	>80	25000	240°	E27	Ø60x108	120W	1/10/50
490820-2	HY/LED/15W/E27/6500K	220-240V	15W	6500K	1520lm	>80	25000	240°	E27	Ø60x108	120W	1/10/50
490819	HY/LED/13W/E27/3000K	220-240V	13W	3000K	1250lm	>80	25000	240°	E27	Ø60x108	100W	1/10/50
490819-2	HY/LED/13W/E27/4000K	220-240V	13W	4000K	1250lm	>80	25000	240°	E27	Ø60x108	100W	1/10/50
490819-1	HY/LED/13W/E27/6500K	220-240V	13W	6500K	1250lm	>80	25000	240°	E27	Ø60x108	100W	1/10/50
490817	HY/LED/11W/E27/3000K	220-240V	11W	3000K	1050lm	>80	25000	240°	E27	Ø60x108	75W	1/10/50
490817-1	HY/LED/11W/E27/4000K	220-240V	11W	4000K	1050lm	>80	25000	240°	E27	Ø60x108	75W	1/10/50
490818	HY/LED/11W/E27/6500K	220-240V	11W	6500K	1050lm	>80	25000	240°	E27	Ø60x108	75W	1/10/50
490647-1	HY/LED/9W/E27/3000K	220-240V	9W	3000K	800 lm	>80	25000	240°	E27	Ø60x108	60W	1/10/50
490647	HY/LED/9W/E27/4000K	220-240V	9W	4000K	824 lm	>80	25000	240°	E27	Ø60x108	60W	1/10/50
490648	HY/LED/9W/E27/6500K	220-240V	9W	6500K	840 lm	>80	25000	240°	E27	Ø60x108	60W	1/10/50

## Led Brilliant Bulbs G45 E27 Globe

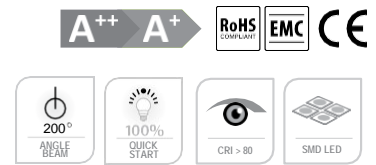

Code	Model no.	Voltage (V)	Power (W)	Temp. (K)	Lumen (Lm)	CRI (Ra)	Life (hrs)	Angle (°)	Base	Dimm. (mm)	Eq.claim	Qty (pcs/ctn)
490643-2	HY/LED/PA/G45/5W/E27/3000K	220-240V	5W	3000K	350	80	25000	200°	E27	Ø50x83	35W	1/10/100
490644-2	HY/LED/PA/G45/5W/E27/6500K	220-240V	5W	6500K	367	80	25000	200°	E27	Ø50x83	35W	1/10/100

## Led Brilliant Bulbs G45 E14 Globe

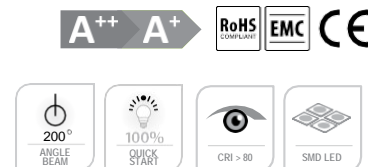

Code	Model no.	Voltage (V)	Power (W)	Temp. (K)	Lumen (Lm)	CRI (Ra)	Life (hrs)	Angle (°)	Base	Dimm. (mm)	Eq.claim	Qty (pcs/ctn)
490643-3	HY/LED/PA/G45/5W/E14/3000K	220-240V	5W	3000K	350	80	25000	200°	E14	Ø45x81	35W	1/10/100
490644-3	HY/LED/PA/G45/5W/E14/6500K	220-240V	5W	6500K	367	80	25000	200°	E14	Ø45x81	35W	1/10/100

## Led Brilliant Bulbs C38 Candle

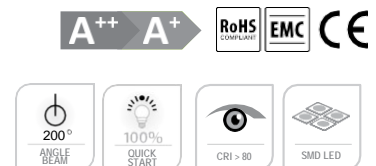

Code	Model no.	Voltage (V)	Power (W)	Temp. (K)	Lumen (Lm)	CRI (Ra)	Life (hrs)	Angle (°)	Base	Dimm. (mm)	Eq.claim	Qty (pcs/ctn)
490645-1	HY/LED/PA/C38/5W/E14/3000K	220-240V	5W	3000K	350	80	25000	200°	E14	Ø38x108	35W	1/10/100
490646-1	HY/LED/PA/C38/5W/E14/6500K	220-240V	5W	6500K	367	80	25000	200°	E14	Ø38x108	35W	1/10/100

## Led Bulb G95/G125 Round



A++ A+ RoHS COMPLIANT EMC CE



Code	Model no.	Voltage (V)	Power (W)	Temp. (K)	Lumen (Lm)	CRI (Ra)	Life (hrs)	Beam Angle (°)	Base	Dimensions (mm)	Quantity (pcs/ctn)
490843-2	HY/LED/G95/12W/E27/3000K	220-240V	12W	3000K	1200	≥80	25000	180°	E27	Ø95x139	1/10/50
490843-3	HY/LED/G95/12W/E27/6500K	220-240V	12W	6500K	1250	≥80	25000	180°	E27	Ø95x139	1/10/50
490843-4	HY/LED/G125/12W/E27/3000K	220-240V	12W	3000K	1200	≥80	25000	180°	E27	Ø125x139	1/20
490843-5	HY/LED/G125/12W/E27/6500K	220-240V	12W	6500K	1250	≥80	25000	180°	E27	Ø125x139	1/20

## Led Bulbs R50 Reflect



A++ A+ RoHS COMPLIANT EMC CE



Code	Model no.	Voltage (V)	Power (W)	Temp. (K)	Lumen (Lm)	CRI (Ra)	Life (hrs)	Beam Angle (°)	Base	Dimensions (mm)	Quantity (pcs/ctn)
490844	HY/LED/R50/6W/E14/3000K	220-240V	6W	3000K	400	≥80	25000	120°	E14	Ø50x83	1/10/50
490844-1	HY/LED/R50/6W/E14/6500K	220-240V	6W	6500K	440	≥80	25000	120°	E14	Ø50x83	1/10/50

## Led Bulbs R63 Reflect

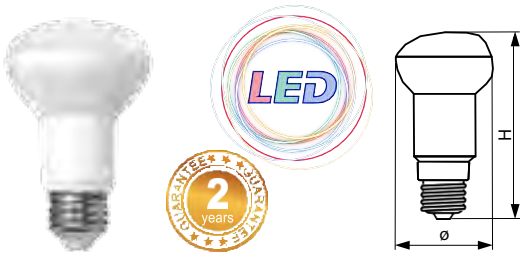

A++ A+ RoHS COMPLIANT EMC CE



Code	Model no.	Voltage (V)	Power (W)	Temp. (K)	Lumen (Lm)	CRI (Ra)	Life (hrs)	Beam Angle (°)	Base	Dimensions (mm)	Quantity (pcs/ctn)
490845	HY/LED/R63/8W/E27/3000K	220-240V	8W	3000K	600	≥80	25000	120°	E27	Ø80x102	1/10/50
490845-1	HY/LED/R63/8W/E27/6500K	220-240V	8W	6500K	660	≥80	25000	120°	E27	Ø80x102	1/10/50

## Led Bulbs G45 Color



A++ A+ RoHS COMPLIANT EMC CE



Code	Model no.	Input Voltage (V)	Nominal Power (W)	Color Temp. (K)	Base	Dimensions (mm)	Quantity (pcs/ctn)
490846	HY/LED/G45/E27/RED	220-240V	1.8W	Red	E27	Ø45x72	1/10/100
490847	HY/LED/G45/E27/GREEN	220-240V	1.8W	Green	E27	Ø45x72	1/10/100
490848	HY/LED/G45/E27/BLUE	220-240V	1.8W	Blue	E27	Ø45x72	1/10/100
490849	HY/LED/G45/E27/YELLOW	220-240V	1.8W	Yellow	E27	Ø45x72	1/10/100

## Led Bulbs E27 Hight Wattage Tulip

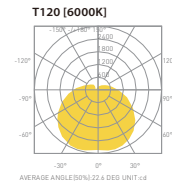
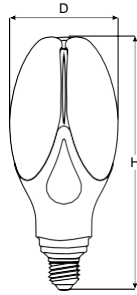

Code	Model no.	Input Voltage (V)	Nominal Power (W)	Color Temp. (K)	Lumen (Lm)	CRI (Ra)	Life (hrs)	Beam Angle (°)	Base	Dimensions (mm)	Quantity (pcs/ctn)
490823-1	HY/HW/TULIP/40W/E27/6500K	220-240V	40W	6500K	4000 lm	≥80	30000	320°	E27	90x212 mm	1/30

## Led Bulbs E27 Hight Wattage



Replace CFL

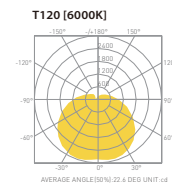
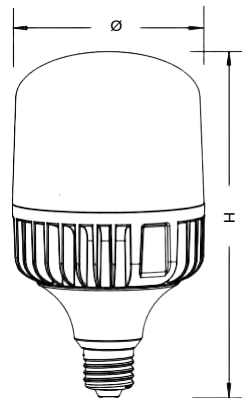

Code	Model no.	Input Voltage (V)	Nominal Power (W)	Color Temp. (K)	Lumen (Lm)	CRI (Ra)	Life (hrs)	Beam Angle (°)	Base	Dimensions (mm)	Quantity (pcs/ctn)
490821	HY/HW/20W/E27/6500K	220-240V	20W	6500K	2200	≥80	30000	270°	E27	80x155 mm	1/40
490822	HY/HW/30W/E27/6500K	220-240V	30W	6500K	3300	≥80	30000	270°	E27	100x183 mm	1/20
490823	HY/HW/40W/E27/6500K	220-240V	40W	6500K	4400	≥80	30000	270°	E27	120x213 mm	1/10

## Led Bulbs E40 Hight Wattage



Replace CFL

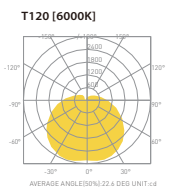
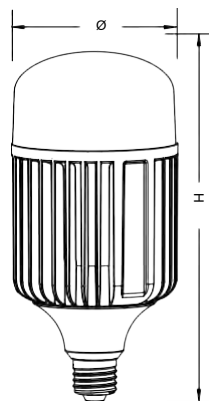

Code	Model no.	Input Voltage (V)	Nominal Power (W)	Color Temp. (K)	Lumen (Lm)	CRI (Ra)	Life (hrs)	Beam Angle (°)	Base	Dimensions (mm)	Quantity (pcs/ctn)
490840	HY/HW/60W/E40/6500K	220-240V	60W	6500K	4800	≥80	30000	160°	E40	80x215 mm	1/20
490841	HY/HW/80W/E40/6500K	220-240V	80W	6500K	6400	≥80	30000	160°	E40	100x245 mm	1/10
490842	HY/HW/100W/E40/6500K	220-240V	100W	6500K	8000	≥80	30000	160°	E40	120x278 mm	1/10

## Cob Led Spotlight GU10 TCP with lens

A++ A+ RoHS COMPLIANT EMC CE

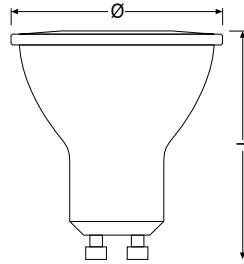

Code	Model no.	Voltage (V)	Nominal Power (W)	Color Temp. (K)	Lumen (Lm)	CRI (Ra)	Life (hrs)	Dimmable	Beam angle (°)	Dimensions (mm)	Base	Quantity (pcs/ctn)
490805	HY/COB/5W/TCPL/GU10/6500K	220-240V	5W	6500K	560	85	40000	NO	60°	Ø50x53	GU10	1/100
490806	HY/COB/5W/TCPL/GU10/3000K	220-240V	5W	3000K	560	85	40000	NO	60°	Ø50x53	GU10	1/100
490810	HY/COB/DIM/5W/TCPL/GU10/6500K	220-240V	5W	6500K	560	85	40000	YES	60°	Ø50x53	GU10	1/100
490811	HY/COB/DIM/5W/TCPL/GU10/3000K	220-240V	5W	3000K	560	85	40000	YES	60°	Ø50x53	GU10	1/100

Light Sources

## Cob Led Spotlight GU10 TCP with lens

A++ A+ RoHS COMPLIANT EMC CE

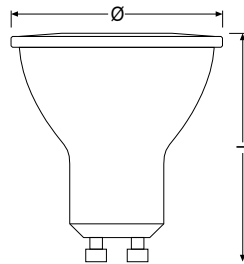

Code	Model no.	Input Voltage (V)	Nominal Power (W)	Color Temp. (K)	Lumen (Lm)	CRI (Ra)	Life (hrs)	Dimmable	Beam angle (°)	Dimensions (mm)	Base	Quantity (pcs/ctn)
490805-2	HY/COB/7W/TCPL/GU10/6500K	220-240V	7W	6500K	600 lm	≥80	40000	NO	60°	Ø50x53	GU10	1/100
490806-2	HY/COB/7W/TCPL/GU10/3000K	220-240V	7W	3000K	600 lm	≥80	40000	NO	60°	Ø50x53	GU10	1/100

## Cob Led Spotlight MR16 TCP with lens

A++ A+ RoHS COMPLIANT EMC CE

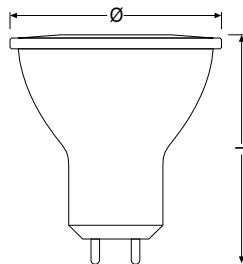

Code	Model no.	Input Voltage (V)	Nominal Power (W)	Color Temp. (K)	Lumen (Lm)	CRI (Ra)	Life (hrs)	Dimmable	Beam angle (°)	Dimensions (mm)	Base	Quantity (pcs/ctn)
490806-1	HY/COB/5W/MR16/GU5.3/3000K	220-240V	5W	3000K	560	85	40000	NO	60°	Ø50x56	GX5.3	1/100
490805-1	HY/COB/5W/MR16/GU5.3/6500K	220-240V	5W	6500K	560	85	40000	NO	60°	Ø50x56	GX5.3	1/100

## Led Lamp G9

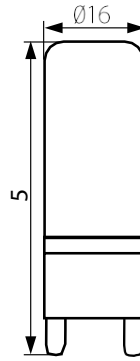

Code	Model no.	Input Voltage (V)	Nominal Power (W)	Color Temp. (K)	Lumen (Lm)	CRI (Ra)	Life (hrs)	Dimmable	Beam angle (°)	Dimensions (mm)	Material	Quantity (pcs/ctn)
490649-2	HY/LED/G9/3,5W/4000K	220-240V	3.5W	4000K	330	80	30000	NO	270°	Ø16x53	PC	1/100/1000
490649-3	HY/LED/G9/3,5W/3000K	220-240V	3.5W	3000K	330	80	30000	NO	270°	Ø16x53	PC	1/100/1000
490649-4	HY/LED/G9/3,5W/6500K	220-240V	3.5W	6500K	400	80	30000	NO	270°	Ø16x53	PC	1/100/1000

## Led Lamp G9 Dimmable

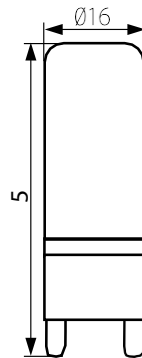

Code	Model no.	Input Voltage (V)	Nominal Power (W)	Color Temp. (K)	Lumen (Lm)	CRI (Ra)	Life (hrs)	Dimmable	Beam angle (°)	Dimensions (mm)	Material	Quantity (pcs/ctn)
490807	HY/LED/G9/3,5W/DIM/4000K	220-240V	3.5W	4000K	330	80	30000	YES	270°	Ø16x53	PC	1/50/300

## Led Lamp G4

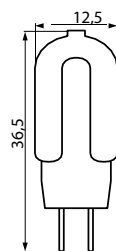

Code	Model no.	Input Voltage (V)	Nominal Power (W)	Color Temp. (K)	Lumen (Lm)	CRI (Ra)	Life (hrs)	Dimmable	Beam angle (°)	Dimensions (mm)	Material	Quantity (pcs/ctn)
490808-1	HY/LED/G4/1,5W/4000K	220-240V	1.5W	4000K	150	80	50000	NO	270°	Ø12.5x36.5	PC	1/50/300

## Led Filament Bulbs A60

A++ A+ RoHS COMPLIANT EMC CE

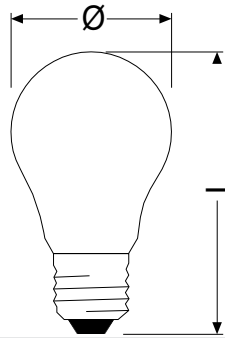

Code	Model no.	Input Voltage (V)	Nominal Power (W)	Color Temp. (K)	Lumen (Lm)	CRI (Ra)	Life (hrs)	Beam Angle (°)	Base	Dimensions (mm)	Quantity (pcs/ctn)
490800	HY/LED/FB/A60/7W/E27/2700K	220-240V	7W	2700K	700	80	25000	290°	E27	Ø60x118	1/10/50

## Led Filament Bulbs G45 E27 Globe

A++ A+ RoHS COMPLIANT EMC CE

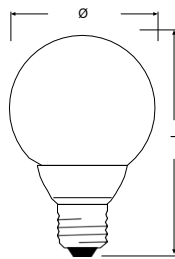

Code	Model no.	Input Voltage (V)	Nominal Power (W)	Color Temp. (K)	Lumen (Lm)	CRI (Ra)	Life (hrs)	Beam angle (°)	Base	Dimensions (mm)	Quantity (pcs/ctn)
490801	HY/LED/FB/G45/4W/E27/2700K	220-240V	4W	2700K	350	80	25000	290°	E27	Ø45x78	1/10/50

## Led Filament Bulbs G45 E14 Globe

A++ A+ RoHS COMPLIANT EMC CE

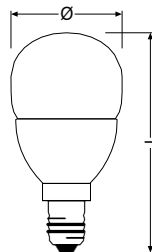

Code	Model no.	Input Voltage (V)	Nominal Power (W)	Color Temp. (K)	Lumen (Lm)	CRI (Ra)	Life (hrs)	Beam angle (°)	Base	Dimensions (mm)	Quantity (pcs/ctn)
490804	HY/LED/FB/G45/4W/E14/2700K	220-240V	4W	2700K	350	80	25000	290°	E14	Ø45x78	1/10/51

## Led Filament Bulbs C35 Candle

A++ A+ RoHS COMPLIANT EMC CE

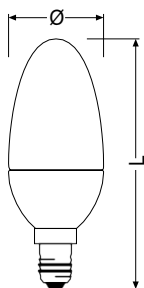

Code	Model no.	Input Voltage (V)	Nominal Power (W)	Color Temp. (K)	Lumen (Lm)	CRI (Ra)	Life (hrs)	Beam angle (°)	Base	Dimensions (mm)	Quantity (pcs/ctn)
490802	HY/LED/FB/C35/4W/E27/2700K	220-240V	4W	2700K	350	80	15000	290°	E14	Ø35x110	1/10/50

## Led Filament Bulbs ST64 Type Amber

A++ A+ RoHS EMC CE

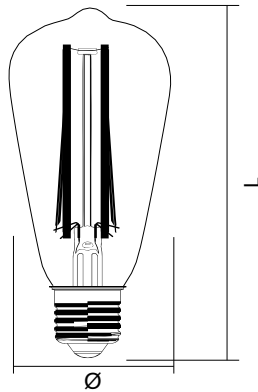

Code	Model no.	Input Voltage (V)	Nominal Power (W)	Color Temp. (K)	Lumen (Lm)	CRI (Ra)	Life (hrs)	Beam Angle (°)	Base	Dimensions (mm)	Quantity (pcs/ctn)
490808	HY/LED/ST64/E27/6W/2200K	220-240V	6W	2200K	650	80	15000	320°	E27	Ø64x138	1/10/50

## Led Filament Bulbs ST56 Type Amber

A++ A+ RoHS EMC CE

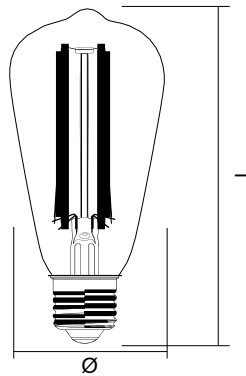

Code	Model no.	Voltage (V)	Nominal Power (W)	Color Temp. (K)	Dimmable	Lumen (Lm)	CRI (Ra)	Life (hrs)	Beam Angle (°)	Base	Dimensions (mm)	Quantity (pcs/ctn)
490808-2	HY/LED/ST56/E27/7W/2200K	220-240V	7W	2200K	YES	800 lm	80	15000	300°	E27	Ø56x126	1/10/50

## Led Filament Bulbs G125 Type Amber

A++ A+ RoHS EMC CE

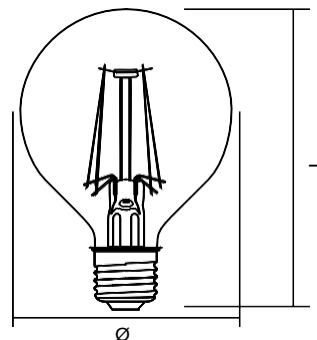

Code	Model no.	Input Voltage (V)	Nominal Power (W)	Color Temp. (K)	Dimmable	Lumen (Lm)	CRI (Ra)	Life (hrs)	Beam angle (°)	Base	Dimensions (mm)	Quantity (pcs/ctn)
490809	HY/LED/G125/E27/6W/2200K	220-240V	6W	2200K	NO	650 lm	80	15000	320°	E27	Ø125x176	1/10/50



# GLASS TUBE

Light Sources



## Glass Led Tube T8, PF 0.9

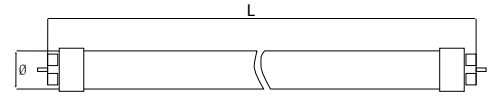

Code	Model no.	Input Voltage (V)	Nominal Power (W)	Color Temp. (K)	Lumen (Lm)	CRI (Ra)	PF	Beam angle (°)	Base	Life (hrs)	Dimensions (mm)	Quantity (pcs/ctn)
490730-1	HY/LED/T8/10W/4000K	180-264VAC	10W	4000K	830	80	0.9	270°	G13	25000	Ø30x602	1/25
490730	HY/LED/T8/10W/6500K	180-264VAC	10W	6500K	900	80	0.9	270°	G13	25000	Ø30x602	1/25
490731-1	HY/LED/T8/20W/4000K	180-264VAC	20W	4000K	1680	80	0.9	270°	G13	25000	Ø30x1212	1/25
490731	HY/LED/T8/20W/6500K	180-264VAC	20W	6500K	1800	80	0.9	270°	G13	25000	Ø30x1212	1/25
490732-1	HY/LED/T8/24W/4000K	180-264VAC	24W	4000K	2300	80	0.9	270°	G13	25000	Ø30x1512	1/25
490732	HY/LED/T8/24W/6500K	180-264VAC	24W	6500K	2400	80	0.9	270°	G13	25000	Ø30x1512	1/25

## Glass Led Tube T8, PF 0.5 ECO

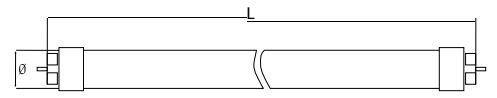

Code	Model no.	Input Voltage (V)	Nominal Power (W)	Color Temp. (K)	Lumen (Lm)	CRI (Ra)	PF	Beam angle (°)	Base	Life (hrs)	Dimensions (mm)	Quantity (pcs/ctn)
490730-2	HY/LED/T8/ECO/9W/6500K	180-264VAC	9W	6500K	750	80	0.5	270°	G13	25000	Ø30x602	1/25
490731-2	HY/LED/T8/ECO/20W/6500K	180-264VAC	20W	6500K	1680	80	0.5	270°	G13	25000	Ø30x1212	1/25
490732-2	HY/LED/T8/ECO/22W/6500K	180-264VAC	22W	6500K	2000	80	0.5	270°	G13	25000	Ø30x1512	1/25

## Promotion Led Tube T8, PF 0.5 Aluminium cap

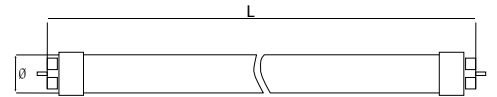
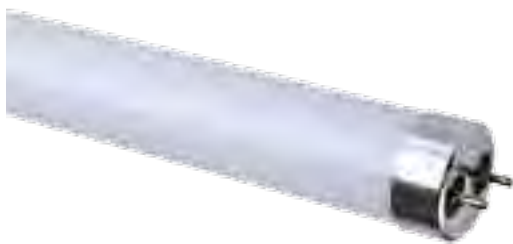

Code	Model no.	Input Voltage (V)	Nominal Power (W)	Color Temp. (K)	Lumen (Lm)	CRI (Ra)	PF	Beam angle (°)	Base	Life (hrs)	Dimensions (mm)	Quantity (pcs/ctn)
490731-3	HY/LED/T8/PROM/18W/6500K	180-264VAC	18W	6500K	1800 lm	≥80	0.5	270°	G13	25000	Ø 30x1212	1/25

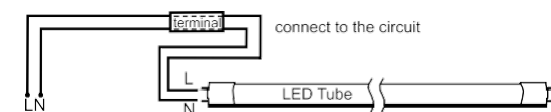

Led Starter

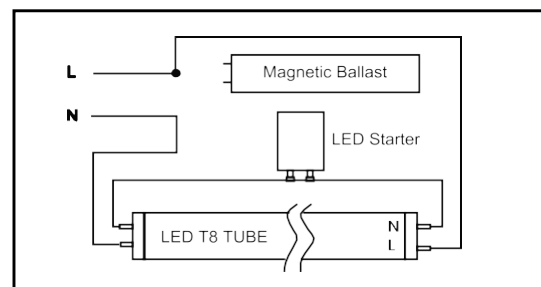

Code	Model no.	Input Voltage (V)	Nominal Power (W)
490752	HY/LS/9-24W	220-240V	9-24W

## INCADESCENT BULBS

### Incandescent A55 bulb

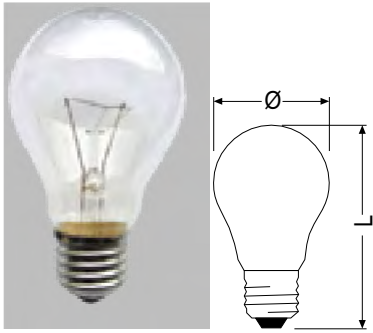

Code	Model no.	Base	Power (W)	Average Life (hrs)	Luminous Flux (lm)	CRI (Ra)	Color Temp. (K)	Quantity (pcs/ctn)	Product Size (Ø/L)
490400	HY/25W/A55/E27	E27	25W	1000	210 lm	100	2700 K	1/100	Ø55x105mm
490401	HY/40W/A55/E27	E27	40W	1000	415 lm	100	2700 K	1/100	Ø55x105mm
490402	HY/60W/A55/E27	E27	60W	1000	710 lm	100	2700 K	1/100	Ø55x105mm
490403	HY/75W/A55/E27	E27	75W	1000	935 lm	100	2700 K	1/100	Ø55x105mm
490404	HY/100W/A55/E27	E27	100W	1000	1340 lm	100	2700 K	1/100	Ø55x105mm

### Incandescent A70 bulb

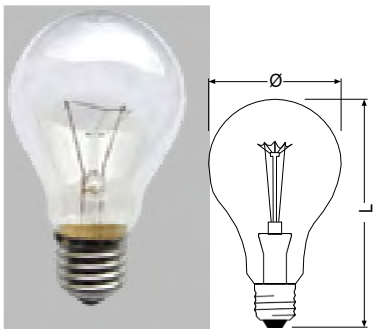

Code	Model no.	Base	Power (W)	Average Life (hrs)	Luminous Flux (lm)	CRI (Ra)	Color Temp. (K)	Quantity (pcs/ctn)	Product Size (Ø/L)
490405	HY/150W/A70/E27	E27	150W	1000	1900 lm	100	2700 K	1/50	Ø70x128mm
490406	HY/200W/A70/E27	E27	200W	1000	2900 lm	100	2700 K	1/50	Ø70x153mm

### Incandescent C35 candle bulbs

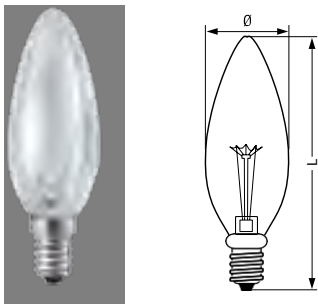

Code	Model no.	Base	Power (W)	Average Life (hrs)	Luminous Flux (lm)	CRI (Ra)	Color Temp. (K)	Quantity (pcs/ctn)	Product Size (Ø/L)
490411	HY/25W/C35/E14	E14	25W	1000	170 lm	100	2700 K	1/100	Ø35x100mm
490412	HY/40W/C35/E14	E14	40W	1000	390 lm	100	2700 K	1/100	Ø35x100mm
490413	HY/60W/C35/E14	E14	60W	1000	580 lm	100	2700 K	1/100	Ø35x100mm

### Incandescent G45 globe bulbs

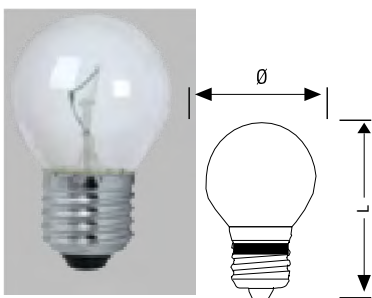

Code	Model no.	Base	Power (W)	Average Life (hrs)	Luminous Flux (lm)	CRI (Ra)	Color Temp. (K)	Quantity (pcs/ctn)	Product Size (Ø/L)
490407	HY/40W/G45/E14	E14	40W	750	390 lm	100	2700 K	1/100	Ø45x75mm
490408	HY/60W/G45/E14	E14	60W	750	580 lm	100	2700 K	1/100	Ø45x75mm
490409	HY/40W/G45/E27	E27	40W	750	390 lm	100	2700 K	1/100	Ø45x75mm
490410	HY/60W/G45/E27	E27	60W	750	580 lm	100	2700 K	1/100	Ø45x75mm

### Incandescent R50 reflecta bulbs

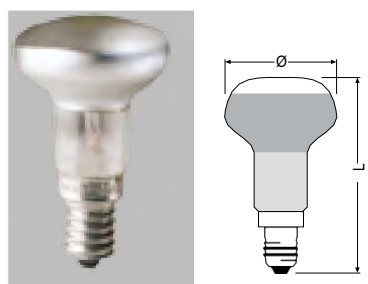

Code	Model no.	Base	Power (W)	Average Life (hrs)	Luminous Flux (lm)	CRI (Ra)	Color Temp. (K)	Quantity (pcs/ctn)	Product Size (Ø/L)
490414	HY/40W/R50/E14	E14	40W	1000	250 lm	100	2700 K	1/100	Ø50x87mm
490415	HY/60W/R50/E14	E14	60W	1000	350 lm	100	2700 K	1/100	Ø50x87mm

## FLUO TUBES

### Fluorescent tubes T8 halophosphor

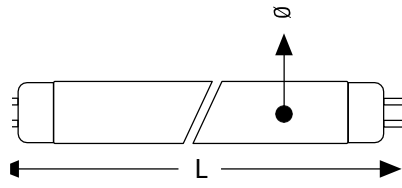

Code	Model no.	Base	Power (W)	Average Life (hrs)	Luminous Flux (lm)	CRI (Ra)	Color Temp. (K)	Quantity (pcs/ctn)	Product Size (Ø/L)
490450	HY/18W/6500K	G13	18W	12,000	970 lm	70	6500 K	1/25	Ø26x604mm
490451	HY/36W/6500K	G13	36W	12,000	2400 lm	70	6500 K	1/25	Ø26x1213mm
490452	HY/58W/6500K	G13	58W	12,000	3900 lm	70	6500 K	1/25	Ø26x1514mm

### Fluorescent tubes T8 triphosphor

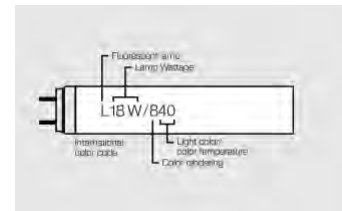
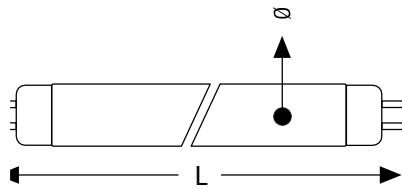
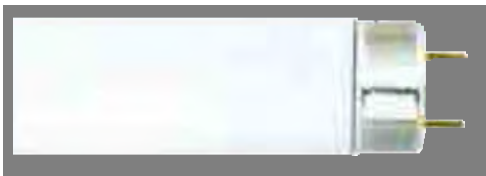

Code	Model no.	Base	Power (W)	Average Life (hrs)	Luminous Flux (lm)	CRI (Ra)	Color Temp. (K)	Quantity (pcs/ctn)	Product Size (Ø/L)
490454	HY/18W/840/4000K	G13	18W	15,000	1390 lm	82	4000 K	1/25	Ø26x604mm
490455	HY/36W/840/4000K	G13	36W	15,000	3450 lm	82	4000 K	1/25	Ø26x1213mm
490456	HY/58W/840/4000K	G13	58W	15,000	5400 lm	82	4000 K	1/25	Ø26x1514mm

### Fluorescent tube T5

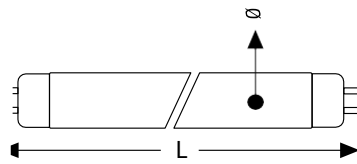

Code	Model no.	Base	Power (W)	Average Life (hrs)	Luminous Flux (lm)	CRI (Ra)	Color Temp. (K)	Quantity (pcs/ctn)	Product Size (Ø/L)
490460	HY/T5/14W/4000K	G5	14W	12,000	1140 lm	82	4000 K	1/25	Ø16x563mm
490461	HY/T5/28W/4000K	G5	28W	12,000	2470 lm	82	4000 K	1/25	Ø16x1163mm
490462	HY/T5/54W/4000K	G5	54W	12,000	4400 lm	82	4000 K	1/25	Ø16x1163mm

### Circle fluorescent T9

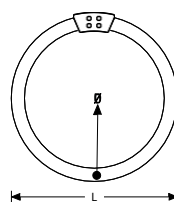

Code	Model no.	Base	Power (W)	Average Life (hrs)	Luminous Flux (lm)	CRI (Ra)	Color Temp. (K)	Quantity (pcs/ctn)	Product Size (Ø/L)
490453	HY/T9/32W	G10q	32W	8000	1900 lm	70	6000 K	1/25	Ø29x299mm

## HID LAMPS

### Metal halide lamps E40

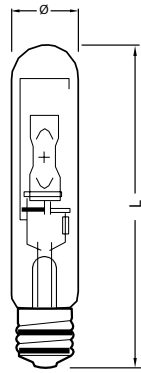

Code	Model no.	Nominal Power (W)	Rated Current (A)	Lumen (lm)	Average Life (hrs)	Color Temperature(K)	Base	Operating Position	Quantity (pcs/ctn)
490205	HY/MH/250W/E40	250W	2.15 A	20000 lm	10000	5200 K	E40	U	1/24
490206	HY/MH/400W/E40	400W	3.25 A	38000 lm	10000	5200 K	E40	U	1/24

### Metal halide lamps R7S

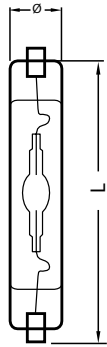

Code	Model no.	Nominal Power (W)	Rated Current (A)	Lumen (lm)	Average Life (hrs)	Color Temperature(K)	Base	Operating Position	Quantity (pcs/ctn)
490203	HY/MH/70W/RX7S/6K	70W	0.98 A	5200 lm	15000	6000 K	R7S	HOR±45°	1/48
490204	HY/MH/150W/RX7S/6K	150W	1.8 A	10000 lm	15000	6000 K	R7S	HOR±45°	1/48

### Metal halide lamps G12

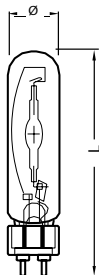

Code	Model no.	Nominal Power (W)	Rated Current (A)	Lumen (lm)	Average Life (hrs)	Color Temperature(K)	Base	Operating Position	Quantity (pcs/ctn)
490200	HY/MH/35W/G12/4K	35W	0.53 A	2700 lm	10000	4200 K	G12	U	1/48
490201-1	HY/MH/70W/G12/4K	70W	0.98 A	5600 lm	10000	4200 K	G12	U	1/48
490202	HY/MH/150W/G12/4K	150W	1.8 A	14000 lm	10000	4200 K	G12	U	1/48

### Sodium lamps E27/E40



Code	Model no.	Nominal Power (W)	Rated Current (A)	Lumen (lm)	Average Life (hrs)	Color Temp.(K)	Base	Operating Position	Quantity (pcs/ctn)
490220	HY/HPS/70W/E27	70W	0.98 A	6000 lm	24000	2000 K	E27	U	1/24
490221	HY/HPS/100W/E40	100W	1.2 A	9000 lm	28000	2000 K	E40	U	1/24
490222	HY/HPS/150W/E40	150W	1.8 A	15000 lm	28000	2000 K	E40	U	1/24
490223	HY/HPS/250W/E40	250W	3.0 A	28000 lm	28000	2000 K	E40	U	1/24
490224	HY/HPS/400W/E40	400W	4.6 A	48000 lm	28000	2000 K	E40	U	1/24

### Mercury lamp E27

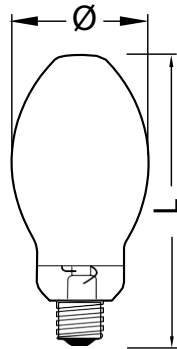

Code	Model no.	Nominal Power (W)	Rated Current (A)	Lumen (lm)	Average Life (hrs)	Color Temp.(K)	Base	Operating Position	Quantity (pcs/ctn)
49025	HY/HPM/125W/E27	125W	1.25 A	6200 lm	10000	-	E27	U	1/24

### Blended mercury lamp E27

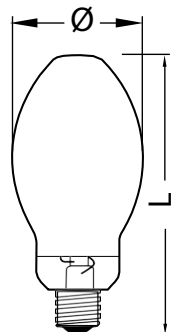

Code	Model no.	Nominal Power (W)	Rated Current (A)	Lumen (lm)	Average Life (hrs)	Color Temp. (K)	Base	Operating Position	Quantity (pcs/ctn)
490210	HY/ML/160W/E27	160W	0.75 A	3200 lm	6000	-	E27	BU	1/24

# SPECIAL FIXTURE

Special Fixtures



## Insect Killer 6W



Code	Model no.	Coverage area (sqm)	UV Tube lamp	Material	Unit Size (cm)	Packing (pcs)
490555	HY/IK/1X6W	20	T5 6W	plastic	36.7x11.3x27.5	15

## Insect Killer 2X8W



Code	Model no.	Coverage area (sqm)	UV Tube lamp	Material	Unit Size (cm)	Packing (pcs)
490551	HY/IK/2x8W	50	T5 2x8W	Aluminium	36.7x9x28.7	6

## Insect Killer 2X20W



Code	Model no.	Coverage area (sqm)	UV Tube lamp	Material	Unit Size (cm)	Packing (pcs)
490550	HY/IK/2x20W	150	T8 2x20W	Aluminium	64x9.9x32	4

## Insect UV Fluo Tube



Code	Model no.	Base	Power (W)	Average Life (hrs)	Quantity (pcs/ctn)
490552	HY/T5-8W/BL	G5	8W	10000 h	25
490553	HY/T8-18W/BL	G13	18W	10000 h	25
490556	HY/T5-6W/BL	G5	6W	10000 h	25



# PROFI CABLE REEL

Extension cords



## Cable Reel PVC

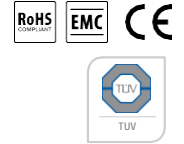

Code	Model no.	m/Max	Wiring	Drum Diameter (mm)	IP	Material
334560	HY/PPJ/25/IP20/3*1.5/PVC	25	H05VV-F (PP/J) 3*1.5	240mm	20	PVC
334561	HY/PPJ/50/IP20/3*1.5/PVC	50	H05VV-F (PP/J) 3*1.5	280mm	20	PVC
334564	HY/PPJ/50/IP20/3*2.5/PVC	50	H05VV-F (PP/J) 3*2.5	280mm	20	PVC
334565	HY/PPJ/25/IP20/3*2.5/PVC	25	H05VV-F (PP/J) 3*2.5	280mm	20	PVC
334566	HY/GGJ/25/IP44/3*2.5/PVC	25	H05RR-F (GG/J) 3*2.5	280mm	44	PVC
334568	HY/GGJ/50/IP44/3*2.5/PVC	50	H05RR-F (GG/J) 3*2.5	280mm	44	PVC
334569	HY/GGJ/50/IP44/3*1.5/PVC	50	H05RR-F (GG/J) 3*1.5	280mm	44	PVC

## Cable Reel Metal

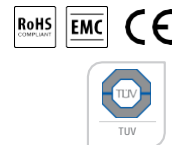

Code	Model no.	m/Max	Wiring	Drum Diameter (mm)	IP	Material
334562	HY/PPJ/50/IP44/3*1.5/M	50	H05VV-F (PP/J) 3*1.5	240mm	44	Metal
334563	HY/PPJ/25/IP44/3*2.5/M	25	H05VV-F (PP/J) 3*2.5	280mm	44	Metal
334567	HY/GGJ/40/IP44/3*2.5/M	40	H05RR-F (GG/J) 3*2.5	280mm	44	Metal

## Cable Reel Without Cable

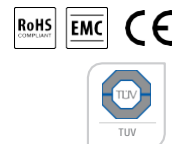

Code	Model no.	m/Max	Drum Diameter (mm)	IP	Material
334570	HY/50/IP44/M	50	280 mm	44	Metal
334571	HY/25/IP20/PVC	25	280 mm	20	PVC

Extension cords

## Extension Cord 3 Sockets



Code	Model no.	No. of socket	Switch	Cable length	Type of cable	Color	Children protection
333953	3S/1.5m 3x1mm2	3	NO	1.5m	H05VV-F 3G1.0	white	YES
333954	3S/1.5m 3x1mm2 with switch	3	YES	1.5m	H05VV-F 3G1.0	white	YES
333955	3S/1.5m 3x1mm2 with switch	3	YES	1.5m	H05VV-F 3G1.0	black	YES
333956	3S/3m 3x1.5mm2	3	NO	3m	H05VV-F 3G1.5	white	YES
333956-1	3S/3m 3x2.5mm2	3	NO	3m	H05VV-F 3G2.5	white	YES
333957	3S/3m 3x1.5mm2 with switch	3	YES	3m	H05VV-F 3G1.5	white	YES
333958	3S/3m 3x1.5mm2 black	3	YES	3m	H05VV-F 3G1.5	black	YES
333959	3S/5m 3x1.5mm2	3	NO	5m	H05VV-F 3G1.5	white	YES
333960	3S/5m 3x1.5mm2 with switch	3	YES	5m	H05VV-F 3G1.5	white	YES
333961	3S/10m 3x1.5mm2	3	NO	10m	H05VV-F 3G1.5	white	YES

## Extension Cord 5 Sockets

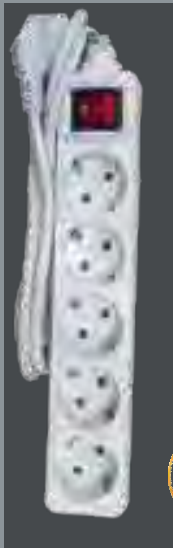

Code	Model no.	No. of socket	Switch	Cable length	Type of cable	Color	Children protection
333962	5S/1.5m 3x1mm2	5	YES	1.5m	H05VV-F 3G1.0	white	YES
333963	5S/3m 3x1.5mm2	5	NO	3m	H05VV-F 3G1.5	white	YES
333964	5S/3m 3x1.5mm2	5	YES	3m	H05VV-F 3G1.5	black	YES
333965	5S/5m 3x1.5mm2	5	NO	5m	H05VV-F 3G1.5	white	YES
333966	5S/5m 3x1.5mm2	5	YES	5m	H05VV-F 3G1.5	black	YES

## Extension Cord 6 Sockets



Code	Model no.	No. of socket	Switch	Cable length	Type of cable	Color	Children protection
333967	6S/1.5m 3x1mm2	6	YES	1.5m	H05VV-F 3G1.0	white	YES
333968	6S/3m 3x1.5mm2	6	YES	3m	H05VV-F 3G1.5	white	YES
333969	6S/3m 3x1.5mm2	6	YES	3m	H05VV-F 3G1.5	black	YES
333970	6S/5m 3x1.5mm2	6	YES	5m	H05VV-F 3G1.5	white	YES
333971	6S/3m 3x1.5mm2 with SURGE PROTECTION	6	YES	3m	H05VV-F 3G1.5	black	YES





Box for extension cord

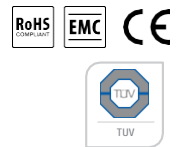

Code	Model no.	No. of socket	Switch	Color	Children protection
333975	BOX/3S	3	NO	white	YES
333976	BOX/3S/with switch	3	YES	white	YES
333977	BOX/5S	5	NO	white	YES
333978	BOX/5S/with switch	5	YES	white	YES

Extension Cord for garden

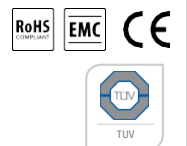

Code	Model no.	Cable length	Type of cable	Color
333972	1S/15m	15 m	H05VV-F 3G1.0	orange
333973	1S/20m	20 m	H05VV-F 3G1.0	orange
333974	1S/25m	25 m	H05VV-F 3G1.0	orange

Extension cords



# ELECTRIC INSTALLATION EQUIPMENT



## Infrared motion sensor 180°

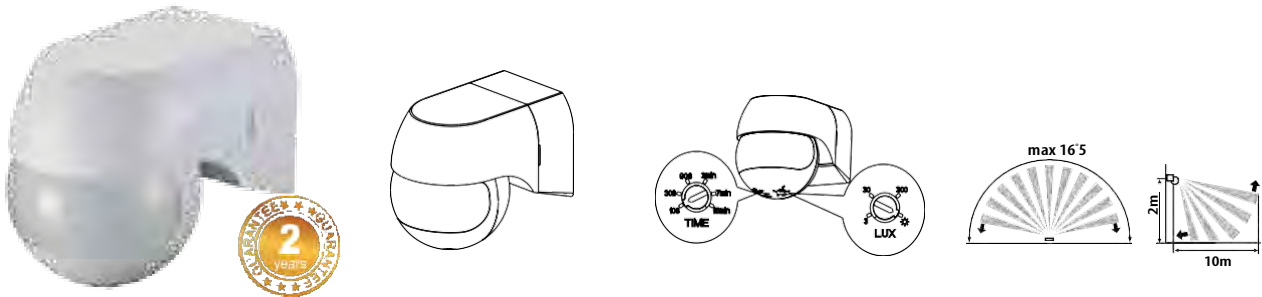

Code	Model no.	Detection Range	Input Voltage (V)	Rated Load (max)	Detection Distance (max/m)	Time Delay	Ambient Light	Installation Height	IP	Color
490670-1	HY/11/180/W	180°	220-240VAC	800W	12m	10sec to 15min (adjustable)	<3-2000LUX (adjustable)	1,8 - 2,5 m	IP44	White

## Infrared motion sensor 360°

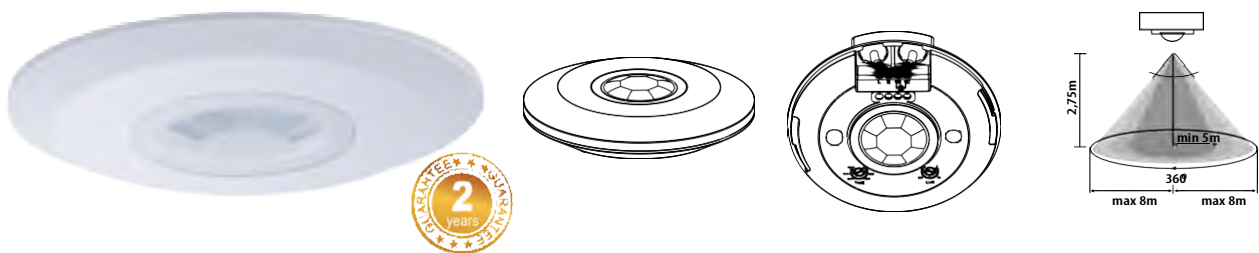

Code	Model no.	Detection Range	Input Voltage (V)	Rated Load (max)	Detection Distance (max/m)	Time Delay	Ambient Light	Installation Height	IP	Color
490671-1	HY/05C/360/W	360°	220-240VAC	2000W	6m	10sec to 15min (adjustable)	<3-2000LUX (adjustable)	2,2 - 4 m	IP44	White

## Infrared motion sensor 360\*

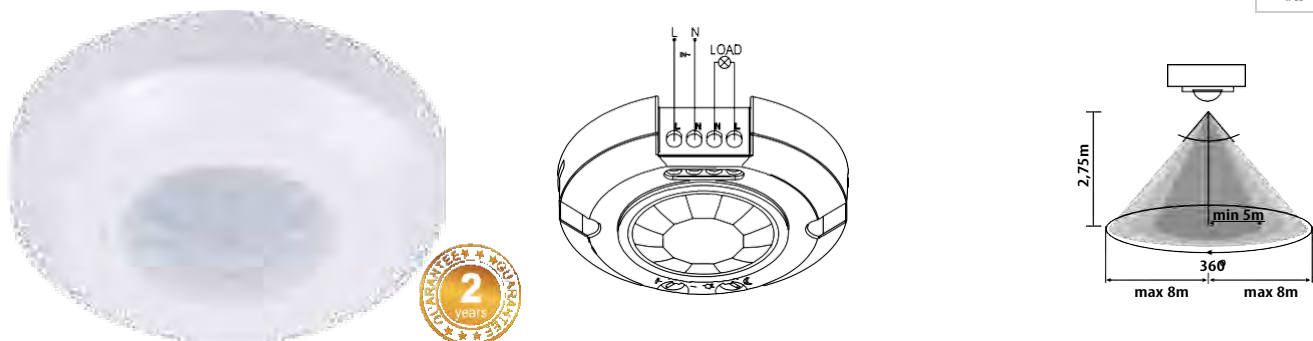

Code	Model no.	Detection Range	Input Voltage (V)	Rated Load (max)	Detection Distance (max/m)	Time Delay	Ambient Light	Installation Height	IP	Color
490671-2	HY/05M/360/W	360°	220-240VAC	400W	8m	10sec to 15min (adjustable)	<3-2000LUX (adjustable)	2,2 - 4 m	IP44	White

## MOTION SENSORS

### Infrared Motion Sensor 180°

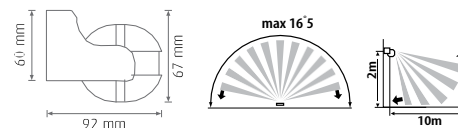

Code	Model no.	Detection Range	Input Voltage(V)	Rated Load (max)	Detection Distance (max/m)	Time Delay	Ambient Light	IP Color
490670	HY/WMS/180/W	180°	220-240VAC	1200W	12m	10sec to 7min (adjustable)	<3-2000LUX (adjustable)	44 White

### Infrared Motion Sensor 360°

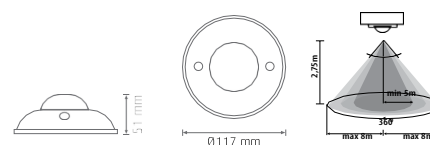

Code	Model no.	Detection Range	Input Voltage(V)	Rated Load (max)	Detection Distance (max/m)	Time Delay	Ambient Light	IP Color
490671	HY/WMS/360/W	360°	220-240VAC	1200W	12m	10sec to 7min (adjustable)	<3-2000LUX (adjustable)	IP44 White

### Infrared Motion Sensor 180° IP65

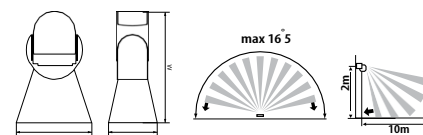

Code	Model no.	Detection Range	Input Voltage (V)	Rated Load (max)	Detection Distance (max/m)	Time Delay
490675	HY/WMS/180/IP65/W	180°	220-240VAC	1200W	12m	10sec to 7min (adjustable)

### Recessed Motion Sensor 360°

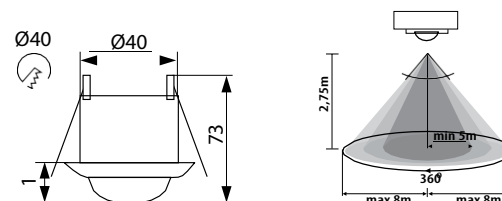

Code	Model no.	Detection Range	Input Voltage(V)	Rated Load (max)	Detection Distance (max/m)	Time Delay	Ambient Light	IP	Color
490677	HY/RMS/360/W	360°	220-240VAC	800W	6m	10sec± 3sec to 15min±2min	<3-2000LUX (adjustable)	IP44	White

# WIFI SOCKET SWITCH



## NEO Wi - Fi Switch



### Remote control

Turn on/off your electrical appliances from anywhere.



### Countdown Timer

Never over charge your electronics again.



### Anti-theft Timer

Pretend you are at home and guard your home.



### Schedule Timer

Perform routine operation automatically for your home appliances



Free NEO app

Wi-Fi socket

CE



Code	Model no.	Input Voltage (V)	Rated Load (max)	Wi-Fi	Color
333993	HY/WIFI/NEO/16A/W	220-240VAC	3500W (16A)	2.4GHz 802.11b/g/n	white

Electrical equipment





## Photo Sensor

CE

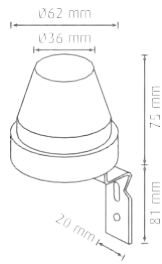

Code	Model no.	Input Voltage(V)	Power Frequency (Hz)	Rated Current (A)	Ambient Light	IP	Color
490673	HY/FS/10A/W	220-240VAC	50/60Hz	10A	<5-50LUX (adjustable)	IP20	White



## Photo Sensor For Din Rail

CE

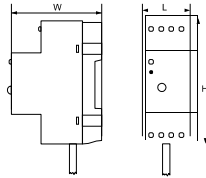

Code	Model no.	Input Voltage(V)	Power Frequency (Hz)	Rated Current (A)	Ambient Light	IP	Color
490679	HY/FS/20A/W	220-240VAC	50/60Hz	20A	<2-100LUX (adjustable)	IP65	White



## Starter for fluorescent tubes

CE

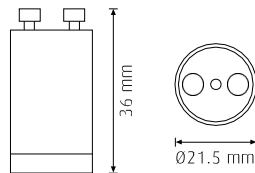

Code	Model no.	Nominal Power (W)
490750	HY/4-22W/FS-2	4-22W
490751	HY/4-65W/FS-U	4-65W



## Electronic ignitor for hid lamps

CE

Code	Model no.	Power of light source
490250	HY/IG/HS/HL/70-400W	70-400W



## Domestic fans

CE

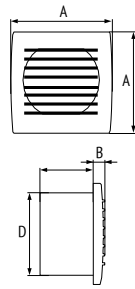

Code	Model no.	Input Voltage(V)	Nominal Power (W)	Volume (m3/h)	Dimensions (mm)			
					A	B	C	D
490050	HY/B04N/100	220-240VAC	15W	100	157	12	60	95
490050-1	LA/B04N/100	220-240VAC	15W	100	157	12	60	95
490051	HY/B05N/120	220-240VAC	20W	195	175	13	60	118
490051-1	LA/B05N/120	220-240VAC	20W	195	175	13	60	118



## 24 Hours Mechanical Timer

CE



Code	Model no.	Input Voltage(V)	Rated Current (A)	Power Frequency (Hz)	Rated Load (max)	Programming	ON/OFF Programs	Min Settings (min)
334591	HY/TS-MD201	220-240VAC	16A	50Hz	3500W	24 hours	24	30 min



## Digital Weekly Timer

CE



Code	Model no.	Input Voltage(V)	Rated Current(A)	Frequency (Hz)	Rated Load (max)	Programming	Battery	Time Display
334590	HY/TS-ED1	220-240VAC	16A	50Hz	3500W	up to 128	Ni-Mh inside	hrs/min/sec

Electrical equipment



# ELECTRIC INSTALLATION EQUIPMENT

Electrical  
equipment

## Rubber Plug With Handle

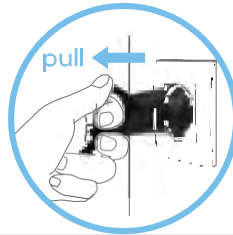

Code	Model no.	Input Voltage (V)	Rated Current (A)	IP	Material	Color
333998	HY/602247/B	220-240VAC	16A	IP44	Rubber	Black

## Schuko Socket With Handle And Cover



Code	Model no.	Input Voltage (V)	Rated Current (A)	IP	Material	Color
333997	HY/602248/B	220-240VAC	16A	IP44	Rubber	Black

## Double Schuko Socket With Handle And Cover



Code	Model no.	Input Voltage (V)	Rated Current (A)	IP	Material	Color
333999	HY/602258/B	220-240VAC	16A	IP44	Rubber	Black



## Adapter 1/3 Sockets 2X USB

Code	Model no.	Body/contact material	Color
333990	HY/R3E-USB/W	PC/copper	White

CE



## Adapter 1/2 Sockets

Code	Model no.	Body/contact material	Color
333988	HY/R2E/W	PC/copper	White

CE



## Adapter 1/3 Sockets

Code	Model no.	Body/contact material	Color
333989	HY/R3E/W	PC/copper	White

CE



## Adapter 1/3 Sockets

Code	Model no.	Body/contact material	Color
333987	HY/417/W	PC/copper	White

CE



## Socket With Earthing

Code	Model no.	Body/contact material	Color
333986	HY/426B/B	Rubber/copper	White

CE



## Plug With Earthing

Code	Model no.	Body/contact material	Color
333985	HY/425B/B	Rubber/copper	White

CE



## I Plug With Earthing

Code	Model no.	Body/contact material	Color
333984	HY/409A/W	PC/copper	White

CE



## L Plug With Earthing

Code	Model no.	Body/contact material	Color
333992	HY/409A/W	PC/copper	White

CE



## Plug

Code	Model no.	Body/contact material	Color
333982	HY/E15/B	PC/copper	Black
333983	HY/E15/W	PC/copper	White

CE



## Intermediate Switch

Code	Model no.	Body/contact material	Color
333980	HY/405C/B HY/E15/B	PC/copper	Black
333981	HY/405C/W HY/E15/W	PC/copper	White

CE

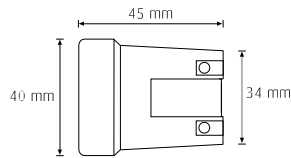

## Ceramic Lampholder E27

CE

Code	Model no.	Body/contact material
490500	HY/B519/E27	Ceramic/copper

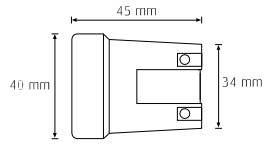

## Ceramic Lampholder E27

CE

Code	Model no.	Body/contact material
490501	HY/B519/E27 HY/B519B/E27	Ceramic/copper

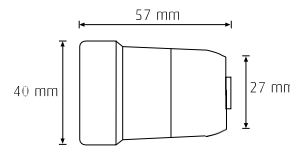

## Ceramic Lampholder E27

CE

Code	Model no.	Body/contact material
490502	HY/B519-2A/E27	Ceramic/copper

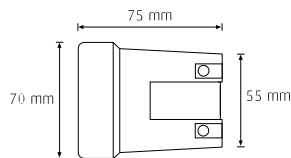

## Ceramic Lampholder E40

CE

Code	Model no.	Body/contact material
490503	HY/B110N-2/E40	Ceramic/copper

## Lampholder G4/G5,3/G6,35

CE

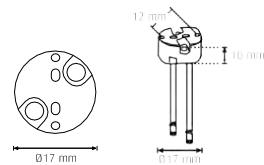

Code	Model no.	Body/contact material
490504	HY/G4/5.3/6.35	Ceramic/copper

## Lampholder GU10

CE

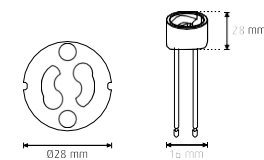

Code	Model no.	Body/contact material
490505	HY/HL-025/GU10	Ceramic/copper

## Lampholder PVC E27

CE

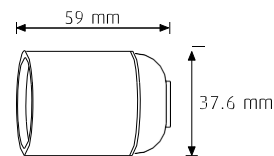
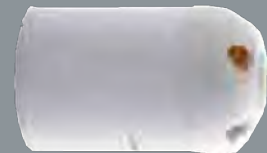

Code	Model no.	Body/contact material
490506	HY/B354/E27 BLACK	PVC/copper
490506-1	HY/B354/E27 WHITE	PVC/copper

## Lampholder E14

CE

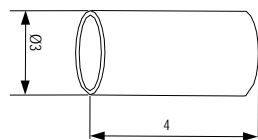

Code	Model no.	Body/contact material
490507	HY/B373B/E14	Bakelite/copper

## Lampholder E27

CE

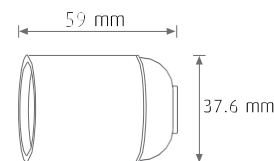

Code	Model no.	Body/contact material
490508	HY/B376/E27	Bakelite/copper

## Lampholder E27

CE

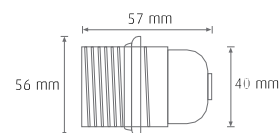

Code	Model no.	Body/contact material
490509	HY/E376D/E27	Bakelite/copper

## RG6 Coaxial Cable



Code	Model no.	Description	Pack (m)
110040	RG6	COAXIAL CABLE RG6 ,1.0 CCS ,4.57 FPE, AL FOIL OD 6.8, 64x0.12 AL	100
110040-1	RG6	COAXIAL CABLE RG6 ,1.0 CCS ,4.57 FPE, AL FOIL OD 6.8, 64x0.12 AL	305
110042	RG6	COAXIAL CABLE RG6 , 1.0 BC, 4.57 FPE, AL FOIL OD 6.8, 64x0.12 BC	100

## RG59 Coaxial Cable



Code	Model no.	Description	Pack (m)
110045	RG59	COAXIAL CABLE RG59, 0.65 CCS ,3.7 FPE, AL FOIL OD 5.2 , 96x0.12 CCA	100
110045-1	RG59	COAXIAL CABLE RG59, 0.65 CCS ,3.7 FPE, AL FOIL OD 5.2 , 96x0.12 CCA	500
110046	RG59	COAXIAL CABLE RG59 0.65 BC, 3.7 FPE, AL FOIL OD 5.2 , 96x0.12 BC	100

## RG59 2X0.5 Coaxial Cable



Code	Model no.	Description	Pack (m)
110047	RG 59+2*0.5	COAXIAL CABLE RG59+2*0.5 , 0.65 CCS ,3.7 SPE, AL FOIL OD 5.2 , 96x0.12 CCA	305

## FTP Cable cat5e



Code	Model no.	Description	Pack (m)
110113	FTP	FTP Cat.5e 4x5x0.5 CCS, 0.9 HDPE, AL FOIL	305

## FTP Cable cat6



Code	Model no.	Description	Pack (m)
110115	FTP	FTP Cat.6 4x2x0.56, CCS, HDPE, AL FOIL, PVC	305
110116	FTP	FTP Cat.6 4x2x0.56, CCS, HDPE, AL FOIL, LSHF	305

## PVC Elec. Insulation Tape 10m

## PVC Elec. Insulation Tape 20m



Code	Product	Color	Quantity (pcs/ctn)
331956	0.13mm x 19mm x 10m	Black	10/250
331957	0.13mm x 19mm x 10m	Red	10/250
331958	0.13mm x 19mm x 10m	White	10/250
331959	0.13mm x 19mm x 10m	Yellow	10/250
331960	0.13mm x 19mm x 10m	Green	10/250
331961	0.13mm x 19mm x 10m	Blue	10/250

Code	Product	Color	Quantity (pcs/ctn)
331949	0.13mm x 19mm x 20m	Yellow/Green	10/200
331950	0.13mm x 19mm x 20m	Black	10/200
331951	0.13mm x 19mm x 20m	Red	10/200
331952	0.13mm x 19mm x 20m	White	10/200
331953	0.13mm x 19mm x 20m	Yellow	10/200
331954	0.13mm x 19mm x 20m	Green	10/200
331955	0.13mm x 19mm x 20m	Blue	10/200

## PVC Elec. Insulation Tape 50mm Wide, 20m



Code	Product	Color	Quantity (pcs/ctn)
331963	0.13mm x 50mm x 20m	White	6/72

## Waterproof Conector I - IP68



Code	Model no.	Max. (A)	Cross section of wire	Dimensions LxW (mm)	Body contact material	Color	Quantity (pcs/ctn)
490523	HY/CN12-3/IP68	16A	2.5mm <sup>2</sup>	78x24mm	brass, PE, Iron	Black	1/600

## Waterproof Conector T - IP68



Code	Model no.	Max. (A)	Cross section of wire	Dimensions LxW (mm)	Body contact material	Color	Quantity (pcs/ctn)
490524	HY/T1-3/IP68	16A	2.5mm <sup>2</sup>	108x25mm	brass, PE, Iron	Black	1/300

## Terminal Blocks PVC



Code	Model no.	Max. (A)	Cross section of wire	Dimensions LxWxH (mm)	Body contact material	Color
490520	HY/PVC/5A	5A	1.5-2.5mm <sup>2</sup>	104x15.3x13.5mm	brass, PE, Iron	White
490521	HY/PVC/10A	10A	4-6mm <sup>2</sup>	113x14.5x17.5mm	brass, PE, Iron	White

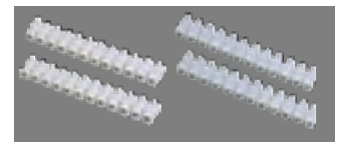

## Cable Ties



Code	Model no.	Dimensions WxL (mm)	Material	Color	Code	Model no.	Dimensions WxL (mm)	Material	Color
490530	HY/2.5x100/W	2.5x100mm	Nylon 66 94V-2 certified by UL	White	490530-1	HY/2.5x100/B	2.5x100mm	Nylon 66 94V-2 certified by UL	Black
490531	HY/2.5x150/W	2.5x150mm			490531-1	HY/2.5x150/B	2.5x150mm		
490532	HY/2.5x200/W	2.5x200mm			490532-1	HY/2.5x200/B	2.5x200mm		
490533	HY/3.6x150/W	3.6x150mm			490533-1	HY/3.6x150/B	3.6x150mm		
490534	HY/3.6x200/W	3.6x200mm			490534-1	HY/3.6x200/B	3.6x200mm		
490535	HY/3.6x250/W	3.6x250mm			490535-1	HY/3.6x250/B	3.6x250mm		
490536	HY/4.8x250/W	4.8x250mm			490536-1	HY/4.8x250/B	4.8x250mm		
490537	HY/4.8x300/W	4.8x300mm			490537-1	HY/4.8x300/B	4.8x300mm		
490538	HY/4.8x350/W	4.8x350mm			490538-1	HY/4.8x350/B	4.8x350mm		
490539	HY/4.8x400/W	4.8x400mm			490539-1	HY/4.8x400/B	4.8x400mm		
490540	HY/9.0x760/W	9.0x760mm	490540-1	HY/9.0x760/B	9.0x760mm				







## SYMBOLS USED IN THE CATALOGUE









### Protection class

The protection class indicates to what extent the lamp is protected against electric shock. All lamps in this catalogue are at least protected with the protection class 1 - a higher class is specified in the information box of the respective lamp.

-  protection class 1: protective earthing
-  protection class 2: protective insulation
-  protection class 3: protective low voltage









### Protection rating

The protection rating ensures the operational safety of luminaires. The first number specifies the extent of the protection against the ingress of foreign bodies; the second number identifies the humidity protection grade. All luminaires in this catalogue are at least protected with the rating IP20 – a higher rating is specified in the information box of the luminaire.

-  IP 20
-  IP 21
-  IP 30
-  IP 44
-  IP 54
-  IP 64
-  IP 65
-  IP 67

### Beam angle

The beam angle describes the „light cone“ emitted by a directional illuminant. It corresponds to the angle at which the luminous intensity is 50% of the centre beam intensity. An illuminant is called directional if at least 80% of its light output is within a cone with an angle of 120°.

-  36°
-  60°
-  90°
-  120°
-  180°
-  180°
-  300°
-  120°  
SENSOR

### Average lifetime

The average lifetime of illuminants describes the time after which 50% of a number of illuminants has failed. For LED illuminants, the average lifetime is defined by a lumen maintenance of 70%.

-  Average lifetime

### Color rendering index

Color rendering index (CRI) is a measure of a light source's ability to show object colors "realistically" or "naturally". Can take values from 0 to 100.

-  Ra > 70
-  Ra > 80
-  Ra > 80
-  Ra > 82



### Dimmable

Light sources labelled as "dimmable" can be dimmed with a suitable commercially available dimmer. The dimmable range for LED might be restricted. If the sign is crossed the illuminant is not dimmable.

-  Dimmable
-  Non-dimmable

### Warm-up time (60 %) (s) Number of switches

Time for warming the lamp up to 60% of its full luminous flux (if the time is less than 1 second, it can be indicated as „instant full light“).

-  < 0,05 s
-  < 2 s

Number of commutations until the untimely failure of lamp.

-  > 10000
-  > 10000
-  > 10000

### Mercury content

The content of Mercury in the lamp. If there is Mercury, this is shown as follows <X.X mg.

-  < X.X mg
-  < X.X mg

### SMD LED

SMD is a type of LED module that use Surface mount technology (SMT) to mount LED chips on printed circuit boards (PCB). SMD LED modules are widely used for backlighting, home illumination, shop-windows, advertising, automobile interior lighting, Christmas lights etc.

-  SMD
-  SMD 3014
-  SMD 3528
-  SMD 5050

### COB LED

COB (Chips on Board) , is a new technology of LED packaging for LED light engine. Multi LED chips are packaged together as one lighting panel. When it light up, it looks like a lighting panel.















-  COB
-  COB BRACKET
- Type of diode

### High power LED







HIGH POWER LED - a certain number of single diodes with small power - usually 1W, connected in a specific way, and mounted in one body covered by optics (lens). They are used in light sources and lighting fixtures with small beam angle and high luminous intensity.

-  High power
- Type of diode

### LAMP BASE

-  E14
-  E27
-  E40
-  GU10
-  G4
-  GU5.3
-  G24d
-  G23
-  2G11
-  G9
-  G13
-  G5
-  G12
-  R7s
-  Rx7s

IMPORTANT: LED luminaires and lamps must not be connected in an electrical circuit, together with luminaires for discharge lamps

	EU directive compatibility mark		SMD LED luminaire		Minimum distance from the illuminated object
	Mounting on the normal flammable base		Compact fluorescent lamp		Groundmounting
	Restriction of Hazardous Substances Directive		GU10 LED lamp		Wall mounting
	Electromagnetic compatibility		GU10 halogen bulb		Ceiling mounting
	Adapted for 230V power supply		MR16 LED lamp		Wall and ceiling mounting
	Adapted for 12V power supply		MR-16 halogen bulb		For outdoor use
	Adapted for 12V direct current power supply		G-9 halogen bulb		For indoor use
	Power supply frequency		JC halogen bulb		For outdoor and indoor use
	The plug is included in the set		Rechargeable		Fixed fitting
	Light source power		MH-7 metal halide lamp		Movable fitting
	Light source current		MH-40 metal halide lamp		Reel length
	Triple rail terminal block 2.5mm <sup>2</sup>		T5 linear fluorescent lamp		
	Triple rail terminal block 2.5mm <sup>2</sup>		T5 linear LED lamp		
	Switch ON / OFF		T8 linear LED lamp		
			T8 linear fluorescent lamp		

## COLOUR TEMPERATURE

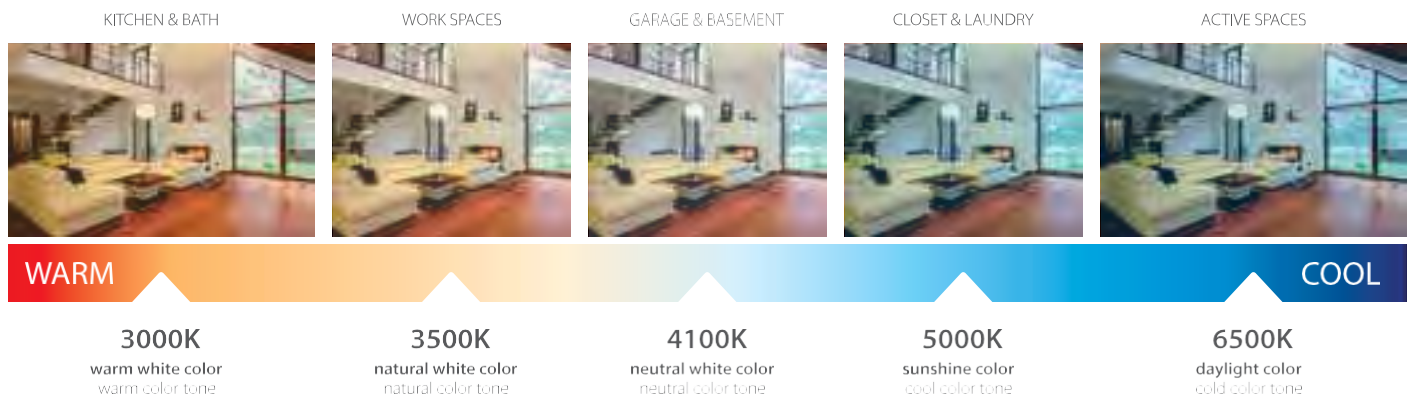



[www.hyundai-lighting.com.mk](http://www.hyundai-lighting.com.mk)

Elektroelement Doo.  
Pero Nakov 25, 1000 Skopje, Macedonia  
+3892 2580 - 800